

MADE IN ITALY. MADE TO EXCEL.

BOOST STONE

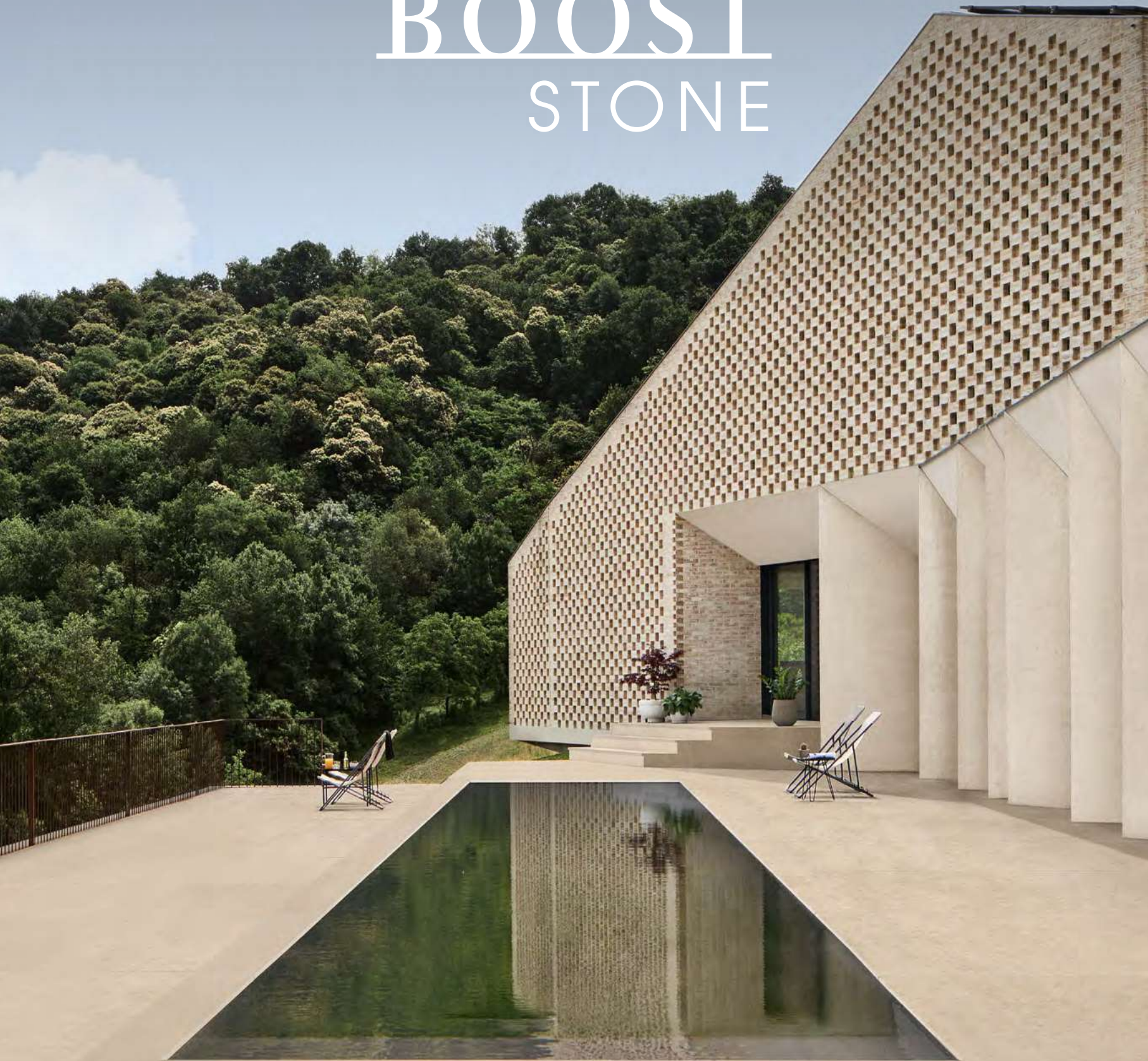



MARBLE LOOK
BOOST
STONE
Porcelain tiles

INDEX

ENJOY THE VIDEO 

Overview



Spaces

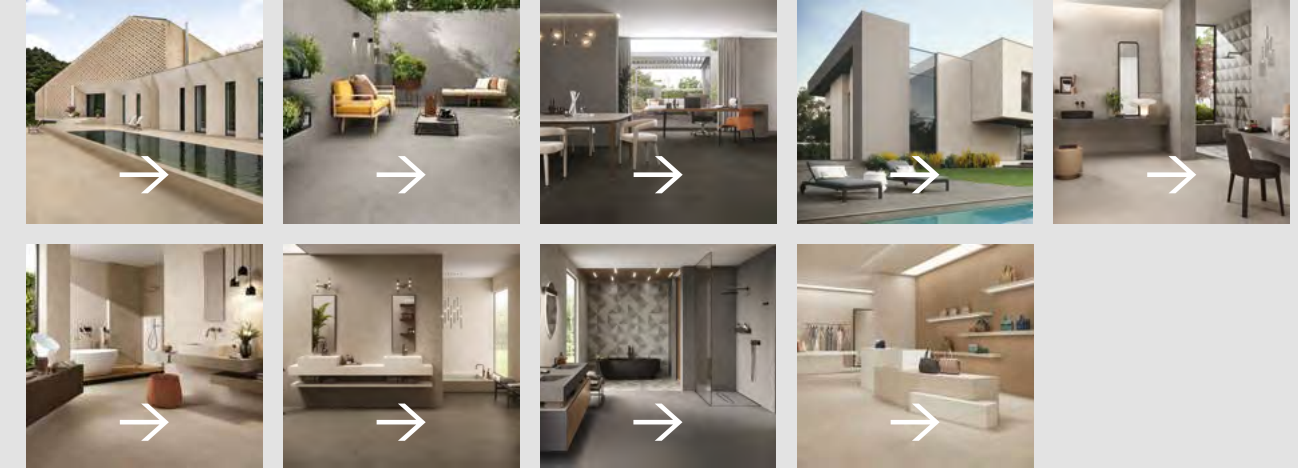

Product Range



Technical Specifications



PORCELAIN TILES: A SAFE CHOICE.

ECO-FRIENDLY
Ama l'ambiente

RECYCLABLE
Riciclabile

FIREPROOF
Non brucia

EASY TO CLEAN
AND DISINFECT
Facile da pulire e sanificare

SAFE
Sicuro

LONG LASTING
Dura a lungo

ZERO PVC
Zero PVC

RESISTANT
Resistente

ZERO VOCS
Zero VOCS

FROST-PROOF
Ingelivo



THE STONE APPEAL.

Boost Stone is the collection of porcelain floor and wall tiles conceived to offer the world of design a modern stone effect. Inspired by the limestone rocks extracted from the quarries of the Pyrenees and produced in a range of neutral tones, it allows you to create environments with a strong contemporary accent.

Boost Stone è la collezione di pavimenti e rivestimenti in gres porcellanato pensata per offrire al mondo della progettazione un moderno effetto pietra. Ispirata alle rocce calcaree estratte dalle cave dei Pirenei e declinata in un ventaglio cromatico di tonalità neutre, permette di creare ambienti dal forte accento contemporaneo.

Boost Stone est la collection de sols et de revêtements muraux en grès cérame conçue pour offrir au monde du design un effet pierre moderne. Inspiré des roches calcaires extraites des carrières des Pyrénées et déclinée dans une gamme chromatique de nuances neutres, elle permet de créer des ambiances à fort accent contemporain.

Boost Stone ist eine Kollektion aus Feinsteinzeugbelägen für Wand und Boden, die dem Planer eine moderne Steinoptik bietet. Sie ist an den Kalkfelsen pyrenäischer Steinbrüche inspiriert und in einer ganzen Palette aus neutralen Farben erhältlich, um Räume mit einem klar kontemporären Akzent zu gestalten.

Boost Stone es una colección de pavimentos y revestimientos de gres porcelánico creada para ofrecer al mundo del diseño un moderno efecto piedra. Inspirada en las piedras calizas extraídas de las canteras de los Pirineos y disponible en una gama de tonos neutros, permite crear ambientes con un fuerte acento contemporáneo.

Boost Stone – это коллекция керамогранита и настенной плитки, задуманная, чтобы предложить миру дизайна современный эффект камня для стильного и современного оформления пространств. У ее истоков – известняк, добываемый в каменоломнях Пиренеев.

ARCHITECTURAL INSTINCT.

Stone-effect surfaces offer architects and designers an infinite number of combinations and total design freedom. With their simple look, they allow floors and walls of residential, commercial, and hospitality spaces to be decorated with a stylistic harmony.

Le superfici effetto pietra consentono ad architetti e designer infinite possibilità di abbinamento e una totale libertà progettuale. Con il loro look essenziale, permettono di rivestire con un'armonia stilistica pavimenti e pareti di spazi residenziali, commerciali e dell'ospitalità.

Les surfaces effet pierre permettent aux architectes et aux concepteurs des possibilités de combinaison infinies et une liberté de conception totale. Avec leur aspect essentiel, elles permettent de couvrir les sols et les murs des espaces résidentiels, commerciaux et d'accueil avec une harmonie stylistique.

Die Beläge in Steinoptik bieten Architekten und Designern unendliche Kombinationsmöglichkeiten und absolute planerische Freiheit. Mit ihrem schlichten Look erlauben sie, Wände und Böden in Wohn- und Gewerberäumen sowie im Gastgewerbe mit stilistischer Harmonie zu verkleiden.

Las superficies de efecto piedra permiten a los arquitectos y diseñadores un sinfín de posibilidades de combinación y una total libertad de diseño. Con su aspecto esencial, permiten revestir suelos y paredes de espacios residenciales, comerciales y hoteleros con armonía y estilo.

Плитка под камень предоставляет архитекторам и дизайнерам бесчисленные возможности сочетания для реализации любых замыслов. Благодаря своему лаконичному виду она способна стильно и гармонично украсить полы и стены домашних пространств, магазинов, отелей, ресторанов.

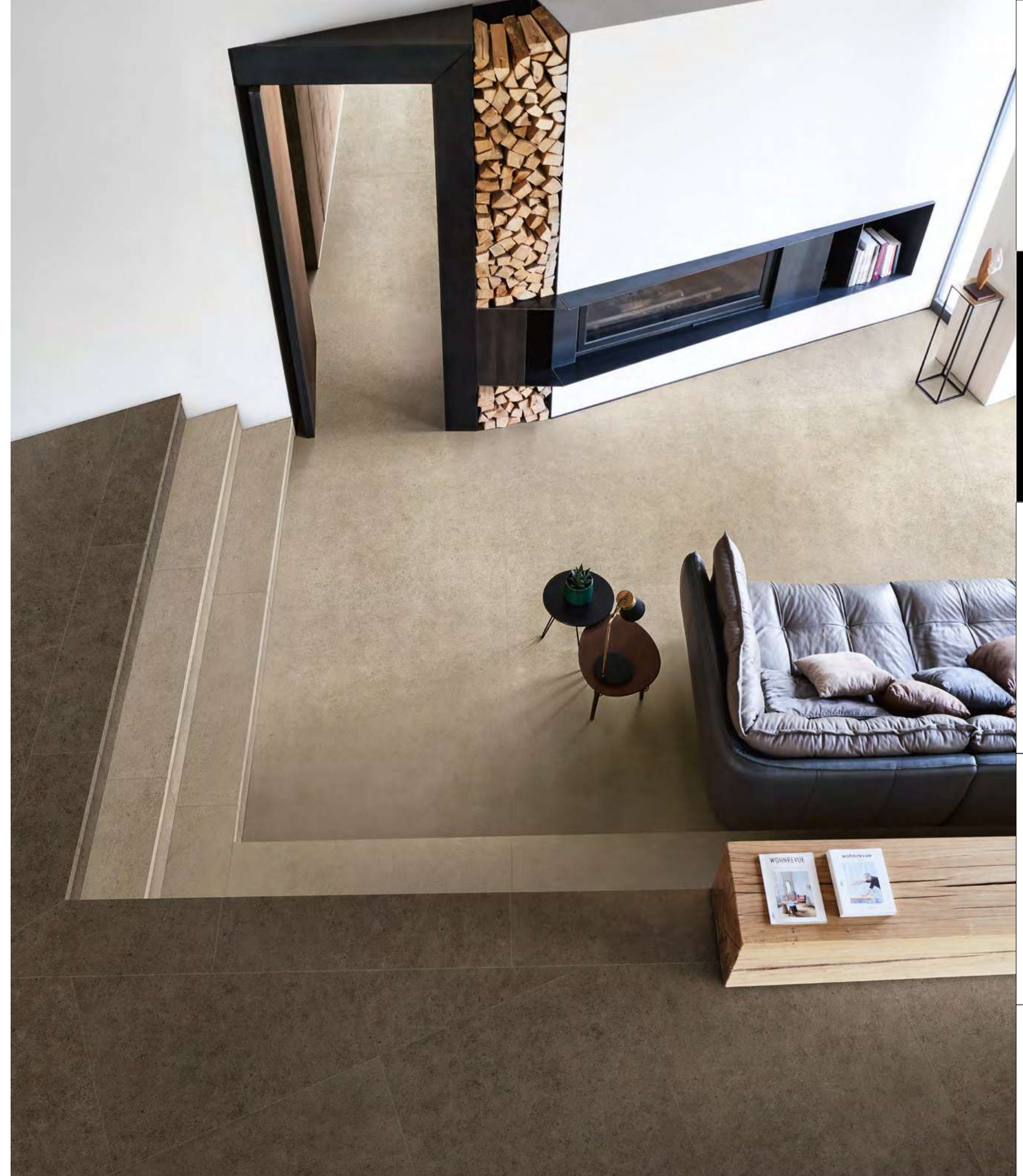



The compact background creates a uniform view with discreet tones, delicate colors, and minimal shading. Upon closer inspection, the texture is enriched with details that reproduce the original stone with extreme realism.

Il fondo compatto restituisce una visione d'insieme omogenea, con toni discreti, cromie delicate e stonalizzazioni minime. A una visione ravvicinata, la texture si arricchisce invece di dettagli riprodotti con estremo realismo che riproducono alla perfezione la superficie variegata della pietra di ispirazione.

Le fond compact donne une vue d'ensemble homogène, avec des tons discrets, des couleurs délicates et un effet dénuancé minimal. À y regarder de plus près, la texture s'enrichit de détails qui reproduisent la pierre d'inspiration avec un réalisme extrême.

Der kompakte Untergrund wird als einheitliche Oberfläche wahrgenommen, mit verhaltenen Nuancen, zarten Farben und minimalen Farbabweichungen. Aus der Nähe betrachtet bereichert sich die Textur hingegen um Details, die den als Vorbild dienenden Stein mit extremem Realismus wiedergeben.

El fondo compacto ofrece una visión de conjunto homogénea, con tonos discretos, colores delicados y contrastes mínimos. Si se observa con detenimiento, la textura se enriquece con detalles que reproducen la piedra fuente de inspiración con un realismo extremo.

Плотную поверхность плитки характеризуют неброская окраска и легкий разнотон, но в целом она дарит ощущение приятной однородности. При рассмотрении с близкого расстояния можно разглядеть детали, которые с предельным реализмом отражают рисунок исходного образца камня.

MORE THAN REAL.



Boost Stone interprets the timeless personality of stone with a palette of ten neutral colors from the concrete-effect world of the Boost and Boost Pro collections. These shades range from light to dark, both in cool and warm colors.

Boost Stone interpreta la personalità senza tempo della pietra con una palette di dieci colori neutri provenienti dal mondo dell'effetto cemento delle collezioni Boost e Boost Pro. Queste tonalità si estendono dalle nuance più chiare a quelle più scure, sia nelle cromie fredde che calde.

Boost Stone interprète la personnalité intemporelle de la pierre avec une palette de dix couleurs neutres issues de l'univers de l'effet béton des collections Boost et Boost Pro. Ces nuances vont des plus claires aux plus foncées, aussi bien dans les couleurs froides que chaudes.

Boost Stone interpretiert die zeitlose Persönlichkeit des Steins mit einer Palette aus zehn neutralen Farben aus der Welt der Zementoptik der Kollektionen Boost und Boost Pro. Diese Farbtöne reichen von helleren bis zu dunkleren Nuancen, in kalten als auch in warmen Farbvarianten.

Boost Stone interpreta la personalidad atemporal de la piedra con una paleta de diez colores neutros del mundo del cemento de las colecciones Boost y Boost Pro. Estas tonalidades van desde los matices más claros a los más oscuros, tanto en colores fríos como cálidos.

Boost Stone интерпретирует вневременную красоту камня в палитре из десяти нейтральных тонов, перенятых у коллекций под цемент Boost и Boost Pro. Палитра охватывает тона от светлых до более темных, как холодных, так и теплых оттенков.

A DIALOG BETWEEN SURFACES.



BOOST STONE



BOOST



BOOST PRO

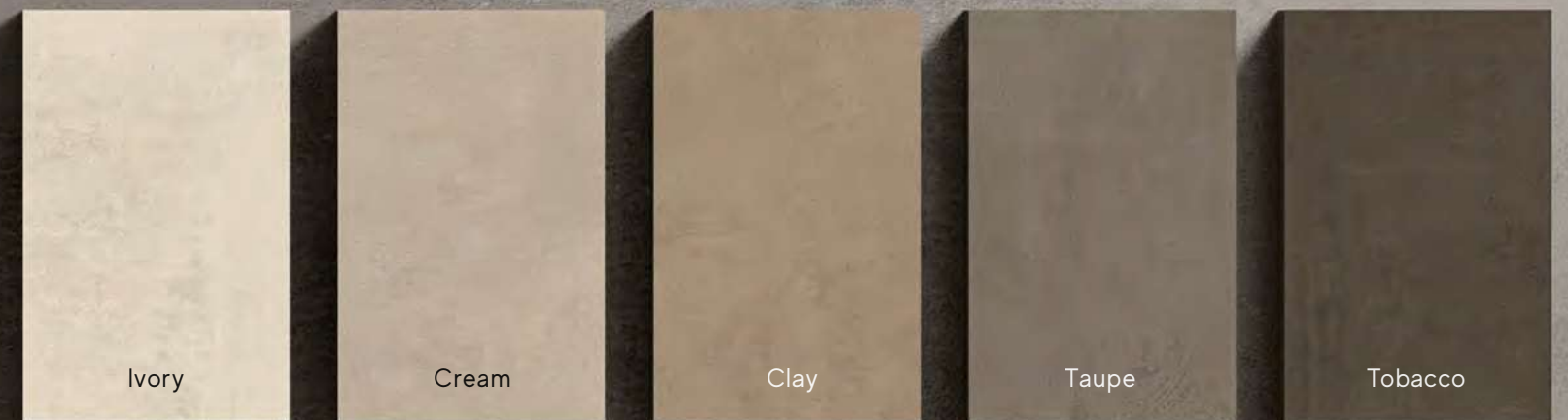



INDEX

OVERVIEW

SPACES

RANGE

TECH. SPECS

CONTEMPORARY COLOR COMBINATIONS.



BROAD HORIZONS.

120x278cm
± 6mm
Available in all colors

The 120x278 size, ideal for expanding the perception of space, can be used to cover walls, exterior facades, and furnishing elements, ensuring greater visual uniformity. Available in ten colors, it offers one of the widest ranges of large-format stone-effect surfaces.

Il formato 120x278, ideale per ampliare la percezione degli spazi, può essere utilizzato per rivestire pareti, facciate esterne ed elementi d'arredo, garantendo una maggiore omogeneità visiva. Disponibile in dieci colorazioni, offre una delle più vaste gamme di superfici effetto pietra in grande formato.

Le format 120x278, idéal pour élargir la perception des espaces, peut être utilisé pour couvrir les murs, les façades extérieures et les éléments d'ameublement, assurant une plus grande homogénéité visuelle. Décliné en dix coloris, il propose l'une des plus larges gammes de surfaces effet pierre grand format.

Das zur optischen Vergrößerung der Räume ideale Format 120x278 kann zur Verkleidung von Wänden, Außenfassaden und Einrichtungs-elementen verwendet werden, um eine größere optische Einheitlichkeit zu gewährleisten. Die zehn Farbvarianten bilden eines der umfassendsten Steinoptik-Sortimente in Großformat.

El tamaño 120x278, ideal para ampliar la percepción de los espacios, puede utilizarse para revestir paredes, fachadas exteriores y elementos de mobiliario, garantizando una mayor uniformidad visual. Está disponible en diez colores y ofrece una de las más amplias gamas de superficies de gran tamaño con efecto piedra.

Формат 120x278 визуальнo делает пространства больше и подходит для облицовки стен, наружных фасадов, предметов интерьера, позволяя придать обстановке эффектную цельность. Доступен в десяти цветах, и эта палитра – одна из самых богатых в том, что касается крупноформатных плит под камень.



THE DIMENSIONS OF DESIGN.

Porcelain Tiles for Floors and Walls

± 6mm ± 9mm

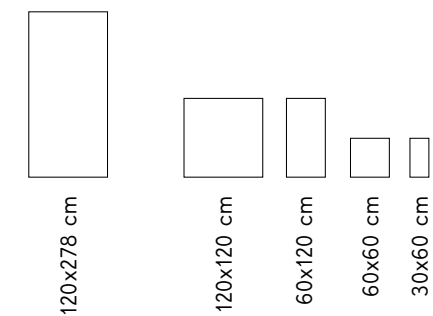

The wide range allows you to design with creativity in every environment, presenting numerous combinations, mixes of colors, and modular formats. The sculpted power of stone is combined with colors, finishes, and decors designed to dialog with the concrete effect of the Boost collections.

L'ampia gamma permette di progettare con creatività in ogni ambiente, presentando numerose combinazioni, intrecci di colori e formati modulari. La forza scultorea della pietra si associa a cromie, finiture e decori progettati per dialogare con l'effetto cemento delle collezioni del mondo Boost.

La large gamme vous permet de concevoir avec créativité dans n'importe quel environnement, en présentant de nombreuses combinaisons, entrelacements de couleurs et formats modulaires. La force sculpturale de la pierre s'allie à des couleurs, des finitions et des décors conçus pour dialoguer avec l'effet béton des collections de l'univers Boost.

Die umfassende Produktpalette erlaubt die kreative Planung jedes Raums mit zahlreichen Kombinationen aus Farben und Formaten. Zur bildhauerischen Kraft des Steins kommen die Farben, Oberflächen und Dekore, die eigens darauf ausgelegt sind, mit der Zementoptik der Kollektionen aus der Welt von Boost kombiniert zu werden.

La amplia gama permite diseñar de forma creativa cualquier ambiente con diferentes combinaciones, tramas de colores y formatos modulares. La fuerza escultórica de la piedra se combina con colores, acabados y decoraciones diseñados para dialogar con el efecto cemento de las colecciones del mundo Boost.

Широкая гамма дает возможность креативно оформлять любое пространство посредством многочисленных комбинаций цветов и модульных форматов. Скульптурная выразительность камня проявляется в большом разнообразии тонов, поверхностных отделок, декоративных элементов и прекрасно сочетается с эффектом цемента коллекций Boost.

LIFE IN THE OPEN AIR.

Porcelain Tiles for Outdoor and Wet Areas

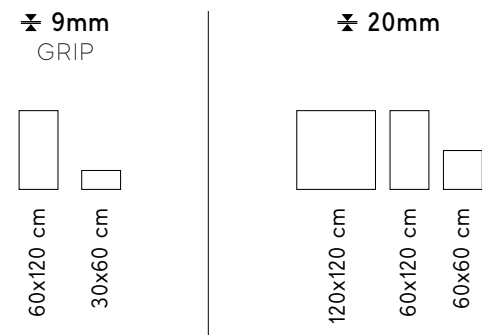

Boost Stone offers a selection of dedicated finishes and increased thicknesses for the design of outdoor spaces that are capable of blending harmoniously into the surrounding natural environment. The various sizes in 9 mm Grip and 20 mm ensure stylistic continuity between the indoors and outdoors, combining a high quality look with superior performance.

Boost Stone propone una selezione di finiture dedicate e spessori maggiorati per la progettazione di spazi outdoor, capaci di integrarsi armonicamente con l'ambiente naturale circostante. I diversi formati in 9mm Grip e 20 mm assicurano una continuità stilistica tra interno ed esterno, combinando un'estetica di pregio a performance elevate.

Boost Stone propose une sélection de finitions dédiées et d'épaisseurs accrues pour la conception d'espaces extérieurs, capables de s'intégrer harmonieusement dans l'environnement naturel environnant. Les différentes tailles en 9 mm Grip et 20 mm assurent une continuité stylistique entre l'intérieur et l'extérieur, alliant une esthétique de haute qualité à des performances élevées.



Boost Stone bietet eine Reihe spezifischer Oberflächen sowie erhöhte Stärken für die Planung von Außenbereichen, die sich harmonisch in die Landschaft integrieren. Die verschiedenen Formate in 9 mm Grip und 20 mm sorgen für stilistische Kontinuität zwischen Drinnen und Draußen, und sie verbinden eine prestigevolle Optik mit hohen Leistungen.

Boost Stone ofrece una selección de acabados dedicados y espesores aumentados para el diseño de espacios exteriores, de manera tal de que se pueda integrar armoniosamente con el entorno natural que los rodea. Los diferentes tamaños de 9 mm Grip y 20 mm garantizan la continuidad estilística entre el interior y el exterior, combinando una estética fina con un alto rendimiento.

Boost Stone предлагает ряд специальных поверхностных отделок и увеличенных толщин для укладки на улице, что позволяет гармонично вписать плитку в ландшафт. С помощью различных форматов толщиной 9 мм Grip и 20 мм интерьер и улицу можно связать в одно стилистическое целое, дополнив эстетику высокими эксплуатационными показателями.

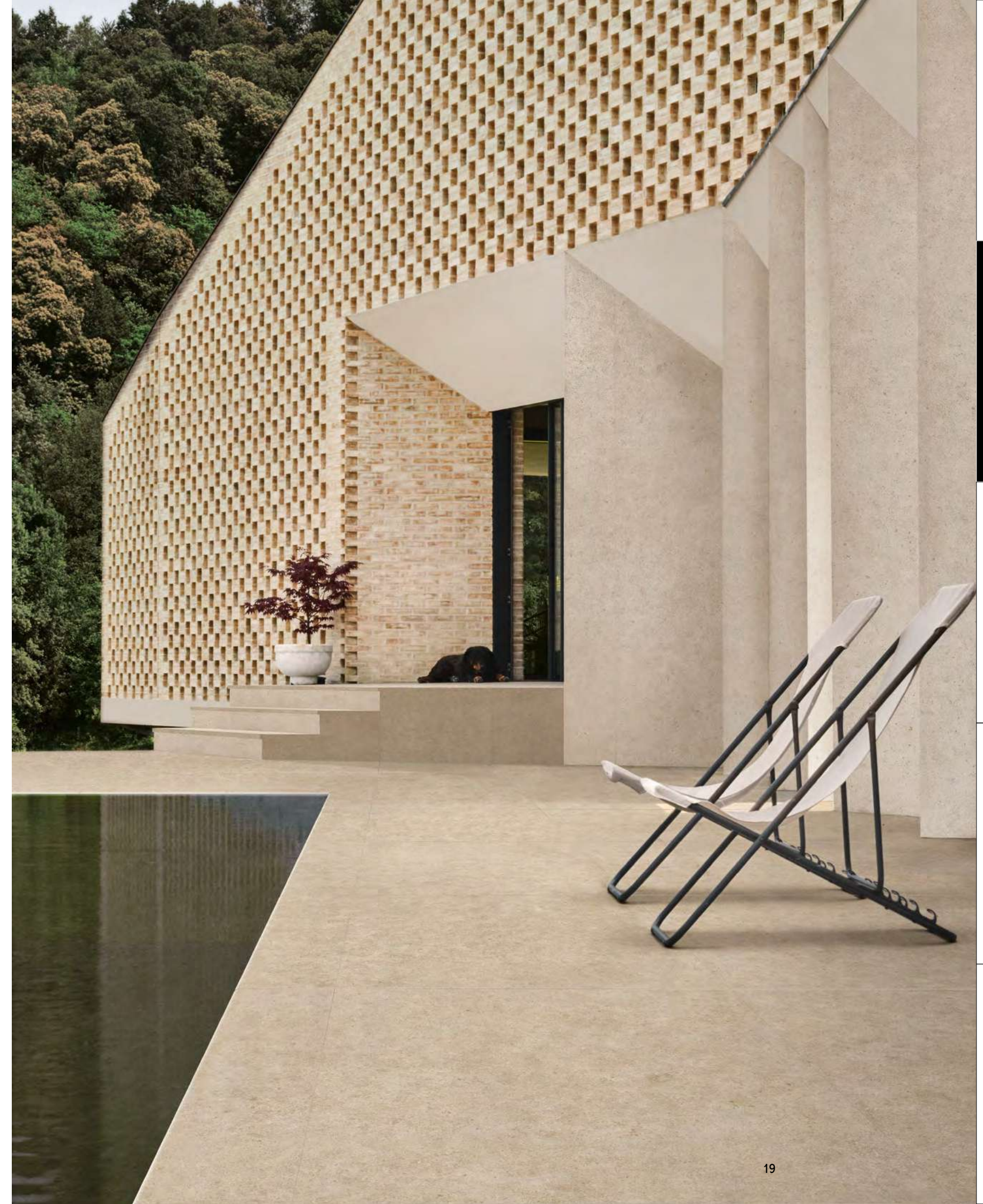



PROJECTS.

- Private Villa In&Out ²²
- Living Room In&Out ³²
- Studio&Terrace ⁵⁰
- Residential outdoor, kitchen ⁵⁸
- Residential Bathroom ⁶⁴
- Residential Bathroom ⁷²
- Wellness Spa&Relax ⁸²
- Commercial Restroom ⁹⁰
- Fashion Showroom ⁹⁸



INDEX

OVERVIEW

SPACES

RANGE

TECH. SPECS



LIMITLESS DESIGN.

atlas concorde

The stone effect of Boost Stone finds its maximum expression in the design of outdoor environments. Here its palette of neutral shades is able to interact harmoniously with the colors of the surrounding nature, giving life to projects with a refined elegance.

L'effetto pietra di Boost Stone trova la massima espressione nella progettazione di ambienti esterni. Qui la palette di sfumature neutre è in grado di intrecciarsi armonicamente con i colori della natura circostante, e dare vita a progetti dalla raffinata eleganza.

L'effet pierre de Boost Stone trouve son expression maximale dans la conception d'environnements extérieurs. Ici, la palette de nuances neutres est capable de s'entrelacer harmonieusement avec les couleurs de la nature environnante, et de donner vie à des projets d'une élégance raffinée.

Die Steinoptik von Boost Stone findet ihren höchsten Ausdruck in der Gestaltung von Außenbereichen. Ihre Palette neutraler Farbtöne lässt sich harmonisch in die Farben der umliegenden Natur integrieren, so dass Projekte von ausgesuchter Eleganz entstehen.

El efecto piedra de Boost Stone se expresa mejor en el diseño de exteriores. Aquí, la paleta de tonos neutros se combina armoniosamente con los colores de la naturaleza circundante y crea proyectos de refinada elegancia.

Эффект камня плиток Boost Stone максимально раскрывает свой потенциал в наружных пространствах. Здесь палитра нейтральных тонов гармонично перекликается с красками окружающего пейзажа, что рождает изысканную элегантность.



PORCELAIN TILE SURFACES CAN COVER FLOORS AND WALLS OF GARDENS, TERRACES, AND POOL AREAS. THEY HAVE A NON-SLIP FINISH AND ARE RESISTANT TO FROST, WEATHERING, WEAR AND TEAR, AND FOOT TRAFFIC.

LE SUPERFICI IN GRES PORCELLANATO POSSONO RIVESTIRE PAVIMENTI E PARETI DI GIARDINI, TERRAZZE E AREE PISCINA. SONO DOTATE DI UNA FINITURA ANTISCIVOLO E RESISTONO A GELO, AGENTI ATMOSFERICI, USURA E CALPESTIO.

LES SURFACES EN GRÈS CÉRAME PEUVENT RECOUVRIR LES SOLS ET LES MURS DES JARDINS, DES TERRASSES ET DES PISCINES. ELLES ONT UNE FINITION ANTIDÉRAPANTE ET RÉSISTENT AU GEL, AUX AGENTS ATMOSPHÉRIQUES, À L'USURE ET À LA CIRCULATION PIÉTONNIÈRE.

FEINSTEINZEUGBELÄGE KÖNNEN BÖDEN UND WÄNDE VON GÄRTEN, TERRASSEN UND SCHWIMMZONEN VERKLEIDEN. SIE HABEN EINE RUTSCHFESTE OBERFLÄCHE UND HALTEN FROST, WITTERUNG, VERSCHLEISS UND TRITTBELASTUNG STAND.

LAS SUPERFICIES DE GRES PORCELÁNICO PUEDEN CUBRIR PAVIMENTOS Y PAREDES EN JARDINES, TERRAZAS Y ZONAS DE PISCINA. TIENEN UN ACABADO ANTIDESLIZANTE Y SON RESISTENTES A LAS HELADAS, LOS CAMBIOS ATMOSFÉRICOS, EL DESGASTE Y LAS PISADAS.

КЕРАМОГРАНИТНОЙ ПЛИТКОЙ МОЖНО ОФОРМЛЯТЬ ПОЛЫ И СТЕНЫ В САДАХ, НА ТЕРРАСАХ, ВОКРУГ БАССЕЙНОВ. ОНА ПРЕПЯТСТВУЕТ СКОЛЬЖЕНИЮ И УСТОЙЧИВА К МОРОЗАМ, АТМОСФЕРНЫМ ВОЗДЕЙСТВИЯМ, ИЗНОСУ, ПЕШЕХОДНЫМ НАГРУЗКАМ.



OUTDOOR PAVING
Boost Stone **Cream** Textured \pm 20 mm
120x120 cm | 47 $\frac{1}{4}$ "x47 $\frac{1}{4}$ "

EXTERNAL FACADE
Boost Stone **Ivory** Matte/Matt
120x278 cm | 47 $\frac{1}{4}$ "x109 $\frac{1}{2}$ "



atlas concorde



LANDSCAPE CONNECTIONS.

FLOOR
Boost Stone **Tobacco** Matte/Matt
120x120 cm | 47 1/4" x 47 1/4"



THE COMPLETE RANGE OF FINISHES AND FORMATS ALLOWS YOU TO CREATE TOTAL-LOOK ENVIRONMENTS AND DESIGN COORDINATED INDOOR AND OUTDOOR SPACES HAVING STYLISTIC AND VISUAL CONTINUITY.

LA GAMMA COMPLETA DI FINITURE E FORMATI CONSENTE DI REALIZZARE AMBIENTI TOTAL LOOK, E PROGETTARE CON UNA CONTINUITÀ STILISTICA E VISIVA SPAZI INTERNI ED ESTERNI COORDINATI.

LA GAMME COMPLÈTE DE FINITIONS ET DE FORMATS PERMET DE CRÉER DES AMBIANCES DE LOOK TOTAL ET DE CONCEVOIR DES ESPACES INTÉRIEURS ET EXTÉRIEURS COORDONNÉS AVEC UNE CONTINUITÉ STYLISTIQUE ET VISUELLE.

DAS KOMPLETTE SORTIMENT AUS OBERFLÄCHEN UND FORMATEN ERLAUBT DIE KREIERUNG EINES TOTAL LOOKS SOWIE EINE STILISTISCHE UND OPTISCHE KONTINUITÄT ZWISCHEN PERFEKT AUF EINANDER ABGESTIMMTEN INNEN- UND AUSSENBEREICHEN.

LA COMPLETA GAMA DE ACABADOS Y TAMAÑOS PERMITE CREAR AMBIENTES CON UN ESTILO COMPLETO Y DISEÑAR ESPACIOS INTERIORES Y EXTERIORES COORDINADOS CON CONTINUIDAD ESTILÍSTICA Y VISUAL.

ШИРОКАЯ ГАММА ПОВЕРХНОСТЕЙ И ФОРМАТОВ ПОЗВОЛЯЕТ ПРИДАВАТЬ ПРОСТРАНСТВАМ ЦЕЛЬНОСТЬ И ОФОРМЛЯТЬ УЛИЦУ В ГАРМОНИИ СО СТИЛЕМ ИНТЕРЬЕРА.



FLOOR
Boost Stone **Tobacco** Matte/Matt
120x120 cm | 47 1/4" x 47 1/4"

Boost Stone **Cream** Matte/Matt
120x120 cm | 47 1/4" x 47 1/4"



NATURAL CONVERGENCE.

INDEX

OVERVIEW

SPACES

RANGE

TECH. SPECS

INDOOR

FLOOR
Boost Stone **Tobacco** Matte/Matt
120x120 cm | 47¹/₄"x47¹/₄"

Boost Stone **Cream** Matte/Matt
120x120 cm | 47¹/₄"x47¹/₄"

WALL
Boost Stone **Cream** Matte/Matt
120x278 cm | 47¹/₄"x109¹/₂"

Boost Stone **Tobacco** Matte/Matt
120x278 cm | 47¹/₄"x109¹/₂"

OUTDOOR

OUTDOOR PAVING
Boost Stone **Cream** Textured \pm 20 mm
120x120 cm | 47¹/₄"x47¹/₄"

EXTERNAL FACADE
Boost Stone **Ivory** Matte/Matt
120x278 cm | 47¹/₄"x109¹/₂"



AUTHENTIC SPACE

For the outdoors, Boost Stone offers a wide range of dedicated surfaces and increased thicknesses. The technical qualities of porcelain tiles ensure durability and high resistance for any application.

Per l'outdoor, Boost Stone propone una vasta offerta di superfici dedicate e spessori maggiorati. Le qualità tecniche del gres porcellanato assicurano durata e resistenza elevata in ogni contesto applicativo.

Pour l'extérieur, Boost Stone propose une large gamme de surfaces dédiées et des épaisseurs accrues. Les qualités techniques du grès cérame garantissent durabilité et haute résistance dans tous les contextes d'application.

Für das Outdoor bietet Boost Stone ein reiches Angebot aus spezifischen Belägen auch in erhöhter Materialstärke. Die technischen Eigenschaften des Feinsteinzeugs garantieren in jedem Anwendungsbereich Langlebigkeit und hohe Beständigkeit.

Para su uso en exteriores, Boost Stone ofrece una amplia gama de superficies dedicadas y de mayor grosor. Las cualidades técnicas del gres porcelánico garantizan la durabilidad y la alta resistencia en cualquier contexto de aplicación.

Для улицы Boost Stone предлагает широкий ассортимент плитки увеличенной толщины. Технические характеристики керамогранита обеспечивают долговечность и стойкость покрытий в любых условиях.

INTENSE VERTICALITY.



OUTDOOR PAVING
Boost Stone **Grey Grip**
120x120 cm | 47¹/₄"x47¹/₄"

OUTDOOR CLADDING
Boost Stone **Grey Matte/Matt**
120x120 cm | 47¹/₄"x47¹/₄"

Boost Stone **Grey Mosaico Brick**
30x60 cm | 11³/₄"x23³/₈"

ATLAS CONCORDE — Boost Stone

34

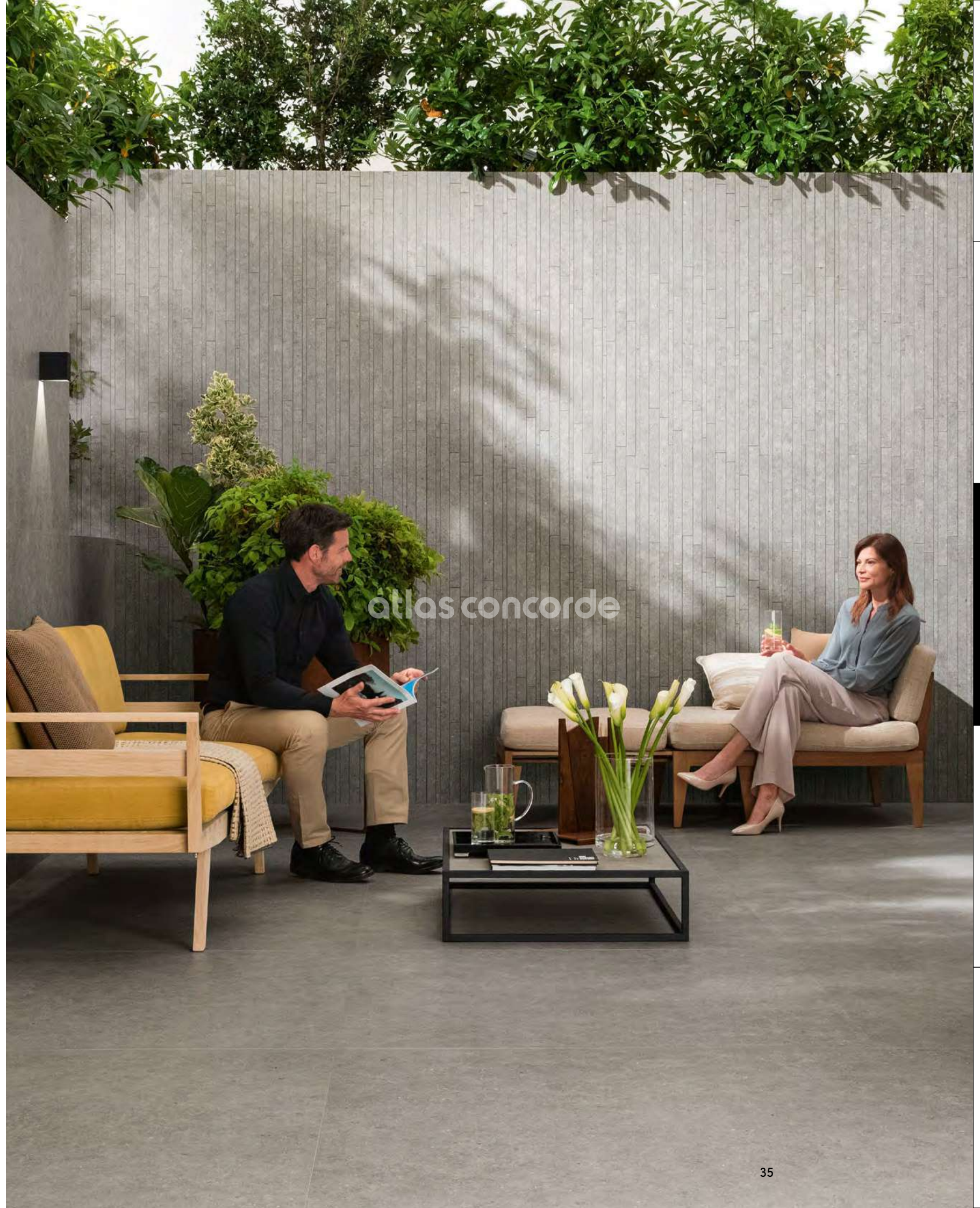

INDEX

OVERVIEW

SPACES

RANGE

TECH. SPECS

35



A PRACTICAL, VERSATILE DECORATIVE ELEMENT, THE BRICK MOSAIC HAS REGULAR STRIPS OF DIFFERENT SIZES THAT CAN BE LAID ON THE WALL - BOTH HORIZONTALLY AND VERTICALLY - AND ON THE FLOOR.

ELEMENTO DECORATIVO PRATICO E VERSATILE, IL MOSAICO BRICK PRESENTA LISTELLI REGOLARI DI DIVERSE DIMENSIONI CHE PUO' ESSERE POSATO A PARETE, SIA IN ORIZZONTALE CHE IN VERTICALE, ED A PAVIMENTO.

ÉLÉMENT DE DÉCORATION PRATIQUE ET POLYVALENT, LA MOSAÏQUE BRICK PRÉSENTE DES BANDES RÉGULIÈRES DE DIFFÉRENTES TAILLES QUI PEUVENT ÊTRE POSÉES AU MUR, AUSSI BIEN HORIZONTALEMENT QUE VERTICALEMENT, ET AU SOL.

DAS FUNKTIONELLE UND VIELSEITIGE DEKORELEMENT MOSAÏK BRICK BESTEHT AUS REGELMÄSSIGEN, ABER UNTERSCHIEDLICH GROSSEN LEISTEN. ES KANN SOWOHL WAAGERECHT ALS AUCH SENKRECHT AN DER WAND UND AUCH AM BODEN VERLEGT WERDEN.

ELEMENTO DECORATIVO PRÁCTICO Y VERSÁTIL, EL MOSAICO BRICK PRESENTA LISTONES REGULARES DE DIFERENTES TAMAÑOS QUE PUEDEN COLOCARSE EN PAREDES, TANTO EN HORIZONTAL COMO EN VERTICAL, Y EN PAVIMENTOS.

МОЗАИКА BRICK - ПРАКТИЧНЫЙ И УНИВЕРСАЛЬНЫЙ ДЕКОРАТИВНЫЙ ЭЛЕМЕНТ. СОСТОИТ ИЗ РОВНЫХ ПЛАНКОВ РАЗНЫХ РАЗМЕРОВ И МОЖЕТ БЫТЬ УЛОЖЕНА НА ПОЛЫ И СТЕНЫ, КАК ВЕРТИКАЛЬНО, ТАК И ГОРИЗОНТАЛЬНО.



OUTDOOR PAVING
Boost Stone **Grey Grip**
120x120 cm | 47¹/₄"x47¹/₄"

OUTDOOR CLADDING
Boost Stone **Grey Mosaic Brick**
30x60 cm | 11³/₄"x23³/₈"

OUTDOOR PAVING
Boost Stone **Grey Grip**
120x120 cm | 47 1/4" x 47 1/4"





atlas concorde

OUTDOOR

OUTDOOR PAVING
 Boost Stone **Grey Grip**
 120x120 cm | 47¹/₄"x47¹/₄"

OUTDOOR CLADDING
 Boost Stone **Grey Matte/Matt**
 120x120 cm | 47¹/₄"x47¹/₄"

Boost Stone **Grey Mosaico Brick**
 30x60 cm | 11³/₄"x23³/₈"



atlas concorde

Neutral tones and the precision of the details give the space a cosmopolitan, contemporary look. Their ability to be perfectly mixed and matched with the colors of the concrete-look Boost collection extends the creative possibilities beyond all limits.

I toni neutri e la precisione dei dettagli donano all'ambiente un look cosmopolita e contemporaneo. La perfetta abbinabilità con le cromie dell'effetto cemento di Boost estende oltre ogni limite le possibilità creative.

Les tons neutres et la précision des détails donnent à l'environnement un aspect cosmopolite et contemporain. La combinaison parfaite avec les couleurs de l'effet béton de Boost étend les possibilités créatives au-delà de toutes les limites.

Die neutralen Farbtöne und präzisen Details verleihen dem Ambiente eine kosmopolitische und kontemporäre Ausstrahlung. Die perfekte Abstimmung auf die Farben der Zementoptik von Boost erweitert das Gestaltungspotenzial ins Unendliche.

Los tonos neutros y los detalles precisos dan al ambiente un aspecto cosmopolita y contemporáneo. La combinación perfecta con los colores de efecto cemento de Boost amplía las posibilidades creativas más allá de todos los límites.

Нейтральные тона и ухоженность деталей придают обстановке современный космополитичный вид. Сочетаемость с цветами плитки под цемент коллекции Boost расширяет дизайнерские возможности до невероятных масштабов.

COSMOPOLITAN MOOD.





atlas concorde

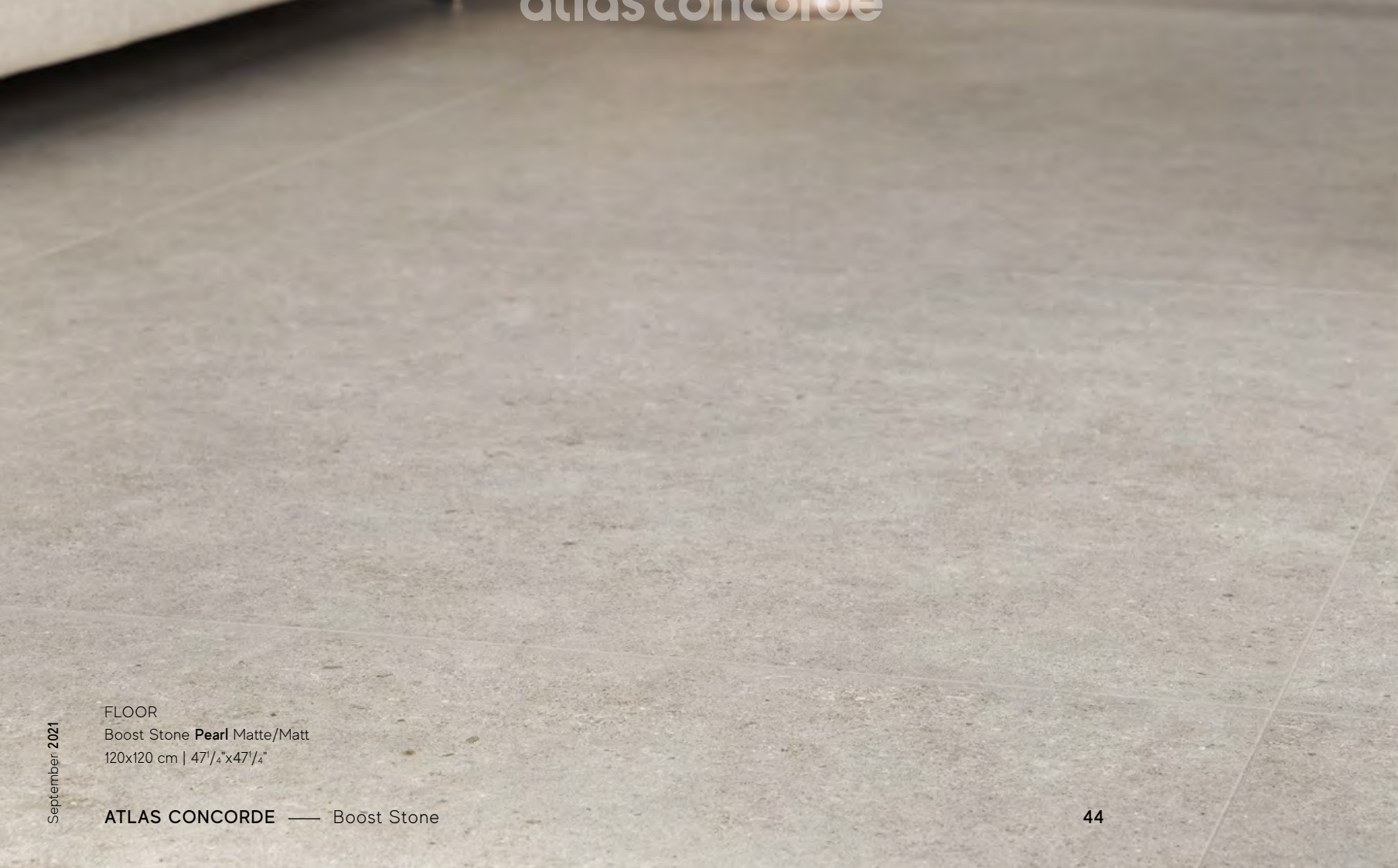

FLOOR
Boost Stone Pearl Matte/Matt
120x120 cm | 47 1/4" x 47 1/4"



atlas concorde

THE DELICATE SHADING AND SLIGHT DIFFERENCES IN TONE OF THE STONE-EFFECT GRAPHICS INSPIRED BY ARGENT ROC ARE WELL SUITED TO THE MOST REFINED SETTINGS WHERE PRESTIGIOUS DETAILS ARE SOUGHT.

LE SFUMATURE DELICATE E LE STONALIZZAZIONI MINIME DELLE GRAFICHE EFFETTO PIETRA ISPIRATE ALLA ARGENT ROC TROVANO LA LORO DESTINAZIONE IDEALE NEI CONTESTI PIÙ RAFFINATI, DOVE SI RICERCA UN DETTAGLIO DI PREGIO.

LES TONS DÉLICATS ET LE RÉSULTAT DÉNUANCÉ MINIMUM DES GRAPHISMES EFFET PIERRE S'INSPIRANT DE L'ARGENT ROC TROUVENT LEUR DESTINATION IDÉALE DANS LES CONTEXTES LES PLUS RAFFINÉS, OÙ UN DÉTAIL PRÉCIEUX EST RECHERCHÉ.

DIE ZARTEN NUANCEN UND DIE MINIMALEN FARBlichen ABWEICHUNGEN DER AM ARGENT ROC INSPIRIERTEN GRAFIKEN IN STEINOPTIK FINDEN IHRE IDEALE VERWENDUNG IN HOCHLEGANTEN KONTEXTEN, IN DENEN PRESTIGEvolle DETAILS ERWARTET WERDEN.

LOS DELICADOS MATICES Y LOS CONTRASTES MÍNIMOS DE LOS GRÁFICOS DE EFECTO PIEDRA INSPIRADOS EN EL ARGENT ROC ENCUENTRAN SU DESTINO IDEAL EN LOS CONTEXTOS MÁS REFINADOS, DONDE SE BUSCA EL DETALLE FINO.

СПОКОЙНЫЕ ОТТЕНКИ И МИНИМАЛЬНЫЙ РАЗНОТОН РИСУНКА КАМНЯ ARGENT ROC ИДЕАЛЬНО ПОДХОДЯТ ДЛЯ ИЗЫСКАННЫХ КОНТЕКСТОВ, ГДЕ ЦЕНЯТСЯ ПРЕСТИЖНЫЕ ДЕТАЛИ.



atlas concorde



atlas concorde

ENGAGING EXPERIENCE.

FLOOR
Boost Stone **Pearl** Matte/Matt
120x120 cm | 47¹/₄"x47¹/₄"

WALL
Boost **Tarmac** Matte/Matt
120x278 cm | 47¹/₄"x109¹/₂"

Boost Stone **Pearl** Mosaico Hex
25x28,5 cm | 9⁷/₈"x11¹/₄"



INDOOR

FLOOR
 Boost Stone **Pearl** Matte/Matt
 120x120 cm | 47¹/₄"x47¹/₄"

WALL
 Boost **Tarmac** Matte/Matt
 120x278 cm | 47¹/₄"x109¹/₂"

Boost **Pearl** Matte/Matt
 120x278 cm | 47¹/₄"x109¹/₂"

Boost Stone **Pearl Mosaico Hex**
 25x28,5 cm | 9⁷/₈"x11¹/₄"



CREATIVE ESSENCE.

The neutral yet decisive tones of the surfaces give each room a contemporary accent. Thanks to their essential look, they revive the design potential of the stone effect in interior design.

Le tonalità neutre ma decise delle superfici caratterizzano ogni ambiente con un accento contemporaneo. Grazie al loro look essenziale, rilanciano le potenzialità progettuali dell'effetto pietra nell'interior design.

Les teintes neutres mais décidées des surfaces caractérisent chaque pièce avec un accent contemporain. Grâce à leur look essentiel, ils relancent le potentiel de design de l'effet pierre en décoration d'intérieur.

Die neutralen und dennoch entschlossenen Farbtöne des Belags prägen jeden Raum mit einer kontemporären Note. Mit ihrem schlichten Look steigern sie das Planungspotenzial der Steinoptik im Innendesign.

Los tonos neutros pero fuertes de las superficies caracterizan cada habitación con un acento contemporáneo. Gracias a su estilo básico, reviven el potencial de diseño del efecto piedra en la decoración de interiores.

Нейтральные, но в то же время решительные тона вносят в интерьер современный акцент. Благодаря лаконичному рисунку поверхности плитка под камень идеальна для создания стильной обстановки.



atlas concorde



atlas concorde

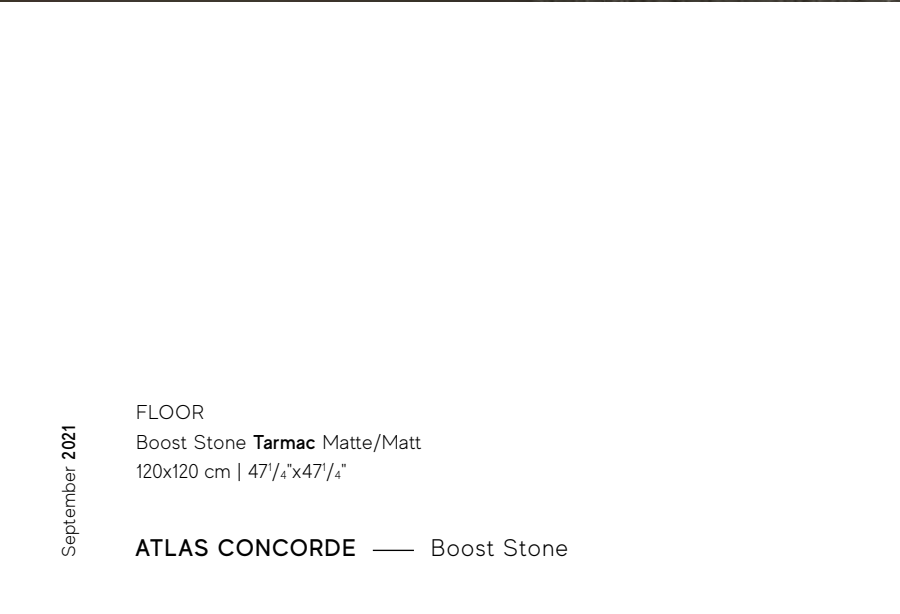

FLOOR
Boost Stone **Tarmac** Matte/Matt
120x120 cm | 47 1/4" x 47 1/4"

ATLAS CONCORDE — Boost Stone



atlas concorde

THE LARGE 120x278 FORMAT IS PERFECTLY MODULAR TO THE FLOOR AND EXPANDS THE CREATIVE POTENTIAL OF SIMPLE, ELEGANT INTERIORS. THE NATURAL FINISH FULLY EXPLOITS THE STONE EFFECT, MAINTAINING ITS TYPICAL OPACITY.

IL GRANDE FORMATO 120x278 È PERFETTAMENTE MODULARE AL PAVIMENTO, E AMPLIA LE POTENZIALITÀ CREATIVE DI INTERNI SOBRI ED ELEGANTI. LA FINITURA NATURALE VALORIZZA AL MEGLIO L'EFFETTO PIETRA, MANTENENDONE LA TIPICA OPACITÀ.

LE GRAND FORMAT 120x278 EST PARFAITEMENT MODULABLE AU SOL, ET ÉLARGIT LE POTENTIEL CRÉATIF D'INTÉRIEURS SOBRES ET ÉLÉGANTS. LA FINITION NATURELLE AMÉLIORE AU MIEUX L'EFFET PIERRE, EN CONSERVANT SON OPACITÉ TYPIQUE.

DAS GROSSFORMAT 120x278 IST MIT DEM BODENBELAG PERFEKT MODULAR UND ERWEITERT DAS KREATIVE POTENZIAL FÜR SCHLICHT-ELEGANTE INNENRÄUME. DIE NATÜRLICHE OBERFLÄCHENAUSFÜHRUNG BRINGT DIE STEINOPTIK MIT DER FÜR SIE TYPISCHEN MATTHEIT MAXIMAL ZUR GELTUNG.

EL TAMAÑO GRANDE 120x278 COMBINA PERFECTAMENTE CON EL PAVIMENTO Y AMPLÍA EL POTENCIAL CREATIVO DE INTERIORES SOBRIOS Y ELEGANTES. EL ACABADO NATURAL APROVECHA AL MÁXIMO EL EFECTO PIEDRA, MANTENIENDO SU TÍPICA OPACIDAD.

БОЛЬШОЙ ФОРМАТ 120x278 СОЧЕТАЕТСЯ ПО РАЗМЕРАМ С НАПОЛЬНОЙ ПЛИТКОЙ, ЧЕМ ПРИДАЕТ ИНТЕРЬЕРАМ СТРОГУЮ ЭЛЕГАНТНОСТЬ. НАТУРАЛЬНАЯ ОТДЕЛКА ПОВЕРХНОСТИ МАКСИМАЛЬНО РАСКРЫВАЕТ КРАСОТУ РИСУНКА КАМНЯ, СОХРАНЯЯ ХАРАКТЕРНУЮ МАТОВОСТЬ.

FLOOR
Boost Stone **Tarmac** Matte/Matt
120x120 cm | 47 1/4" x 47 1/4"

WALL
Boost Stone **Smoke** Matte/Matt
120x278 cm | 47 1/4" x 109 1/2"

ATLAS CONCORDE — Boost Stone



atlas concorde



atlas concorde



atlas concorde

REFINED TRANSITIONS.

INDOOR

FLOOR

Boost Stone **Tarmac** Matte/Matt
120x120 cm | 47¹/₄"x47¹/₄"

WALL

Boost Stone **Smoke** Matte/Matt
120x278 cm | 47¹/₄"x109¹/₂"

Boost **Pearl** Matte/Matt
120x278 cm | 47¹/₄"x109¹/₂"

MAXIMUM EXPRESSION.

atlasconcorde

OUTDOOR PAVING
Boost Stone **Grey Textured Outdoor** ± 20 mm
120x120 cm | 47¹/₈"x47¹/₈"

VENTILATED FACADE
Boost Stone **White Matte/Matt**
60x120 cm | 23³/₈"x47¹/₈"

The surfaces are extremely versatile. Outside they can also be used to design ventilated facades. Inside they adapt to worktops, backsplashes, and tables of all sizes.

Le superfici sono estremamente versatili. In esterno, possono essere impiegate anche per la progettazione di facciate ventilate. In interno, si adattano a piani lavoro, backsplash e tavoli di ogni dimensione.

Ces surfaces sont extrêmement polyvalentes. En extérieur, elles peuvent également être utilisées pour la conception de façades ventilées. En intérieur, elles s'adaptent aux plans de travail, dosserets et tables de toutes dimensions.

Die Oberflächen sind extrem vielseitig. Im Freien können sie auch für hinterlüftete Fassaden verwendet werden. Im Innenbereich eignen sie sich für Arbeitsplatten, Küchenrückwände und Tische jeder Größe.

Las superficies son extremadamente versátiles. En exteriores, también pueden utilizarse para diseñar fachadas ventiladas. En interiores, son buenas para encimeras, salpicaderos y mesas de todos los tamaños.

Плитка многофункциональна. В наружных пространствах ею можно облицовывать также вентилируемые фасады. В интерьерах она подходит для покрытия столешниц, фартуков, столов любого размера.



FLOOR
Boost Natural **Ecrú** Matte/Matt
120x120 cm | 47 1/4"x47 1/4"

WALL
Boost Natural **Ecrú** Matte/Matt
120x278 cm | 47 1/4"x109 1/2"

COUNTERTOP
AtlasPlan
Boost Stone **Ivory** Hammered \pm 12 mm
162x324 cm | 63 3/4"x127 1/2"

CABINET DOORS
Boost Stone **Ivory** Matte/Matt \pm 6 mm

atlasconcorde



OUTDOOR

OUTDOOR PAVING

Boost Stone **Grey** Textured Outdoor ± 20 mm
120x120 cm | 47¹/₄"x47¹/₄"

VENTILATED FACADE

Boost Stone **White** Matte/Matt
60x120 cm | 23⁵/₈"x47¹/₄"

INDOOR

FLOOR

Boost Natural **Ecrú** Matte/Matt
120x120 cm | 47¹/₄"x47¹/₄"

WALL

Boost Natural **Ecrú** Matte/Matt
120x278 cm | 47¹/₄"x109¹/₂"

FURNITURE

COUNTERTOP

AtlasPlan
Boost Stone **Ivory** Hammered ± 12 mm
162x324 cm | 63³/₄"x127¹/₂"

CABINET DOORS

Boost Stone **Ivory** Matte/Matt ± 6 mm



AESTHETIC VIBRATION.

atlas concorde

Thanks to their versatility, the surfaces can be used both to design total-look environments and to create spaces where the stone effect coexists harmoniously with other materials.

Grazie alla loro versatilità, le superfici possono essere utilizzate sia per progettare ambienti total look che per creare spazi dove l'effetto pietra convive armonicamente con altri materiali.

Grâce à leur polyvalence, les surfaces peuvent être utilisées à la fois pour concevoir des environnements au look total et pour créer des espaces où l'effet pierre coexiste harmonieusement avec d'autres matériaux.

Dank ihrer Vielseitigkeit sind die Beläge sowohl für Räume im Total Look verwendbar als auch für einen harmonischen Mix der Steinoptik mit anderen Materialien.

Gracias a su versatilidad, las superficies pueden utilizarse tanto para diseñar ambientes con un estilo acabado como para crear espacios en los que el efecto de la piedra conviva armoniosamente con otros materiales.

Благодаря ее универсальности плитку под камень можно использовать как для оформления интерьера в стиле тотал-лук, так и для сочетания с другими материалами.



atlas concorde



atlas concorde

FLOOR
Boost Stone **White** Matte/Matt
120x120 cm | 47³/₈"x47³/₈"

SHOWER
Boost Stone **Mosaico Cube Cold**
30x30 cm | 11³/₈"x11³/₈"

WALL
Boost Stone **White** Matte/Matt
60x120 cm | 23³/₈"x47³/₈"

TOP/SHELFS
Boost **Smoke** Matte/Matt

Boost **Pearl** Matte/Matt
60x120 cm | 23³/₈"x47³/₈"

IMMERSIVE CORNER.



atlas concorde

THE SOFT SHADES OF BOOST STONE CONVEY A FEELING OF COMFORT THAT IS PERFECT FOR THE WALLS AND FLOORS OF A SPACE DEDICATED TO BODY CARE. A DELICATE, SUFFUSED VIBRATION CROSSES THE SURFACES WITH AN EFFECT OF AUTHENTICITY AND REALISM.

LE TONALITÀ MORBIDE DI BOOST STONE TRASMETTONO UNA SENSAZIONE DI COMFORT PERFETTA PER LE PARETI E I PAVIMENTI DI UNO SPAZIO DEDICATO ALLA CURA DEL CORPO. UNA DELICATA VIBRAZIONE DIFFUSA ATTRAVERSA LE SUPERFICI CON UN EFFETTO DI AUTENTICITÀ E REALISMO.

LES TONS DOUX DE BOOST STONE TRANSMETTENT UNE SENSATION DE CONFORT PARFAITE POUR LES MURS ET LES SOLS D'UN ESPACE DÉDIÉ AUX SOINS DU CORPS. UNE DÉLICATE VIBRATION DIFFUSE TRAVERSE LES SURFACES AVEC UN EFFET D'AUTENTICITÉ ET DE RÉALISME.

DIE WEICHEN FARBTÖNE VON BOOST STONE AN BODEN UND WAND VERMITTELN EIN GEFÜHL VOLLKOMMENEN KOMFORTS IN DER KÖRPERPFLEGE GEWIDMETEN RÄUMEN. ZARTE, DIFFUSE SCHWINGUNGEN DURCHZIEHEN DIE OBERFLÄCHEN UND ERZEUGEN DEN EINDRUCK VON AUTHENTIZITÄT UND REALISMUS.

LOS TONOS SUAVES DE BOOST STONE TRANSMITEN UNA SENSACIÓN DE CONFORT QUE ES PERFECTA PARA LAS PAREDES Y LOS SUELOS DE UN ESPACIO DEDICADO AL CUIDADO DEL CUERPO. UNA DELICADA VIBRACIÓN RECORRE LAS SUPERFICIES CON UN EFECTO DE AUTENTICIDAD Y REALISMO.

МЯГКИЕ ТОНА BOOST STONE ДАРЯТ ОЩУЩЕНИЕ КОМФОРТА, ПОЭТОМУ ИДЕАЛЬНО ПОДХОДЯТ ДЛЯ ОБЛИЦОВКИ ПОЛОВ И СТЕН В ВАННЫХ КОМНАТАХ. ДЕЛИКАТНАЯ ФАКТУРА ПОВЕРХНОСТЕЙ АУТЕНТИЧНА И РЕАЛИСТИЧНА.



atlas concorde

FLOOR
Boost Stone **White** Matte/Matt
120x120 cm | 47^{5/8}"x47^{1/4}"

WALL
Boost Stone **White** Matte/Matt
60x120 cm | 23^{5/8}"x47^{1/4}"

TOP/SHELFS
Boost **Smoke** Matte/Matt



atlas concorde



atlas concorde

INDOOR

FLOOR
Boost Stone **White** Matte/Matt
120x120 cm | 47⁵/₈"x47⁵/₈"

WALL
Boost Stone **White** Matte/Matt
60x120 cm | 23⁵/₈"x47⁵/₈"

Boost **Pearl** Matte/Matt
60x120 cm | 23⁵/₈"x47⁵/₈"

SHOWER
Boost Stone **Mosaico Cube Cold**
30x30 cm | 11³/₄"x11³/₄"

FURNITURE

TOP/SHELFS
Boost **Smoke** Matte/Matt



A MATTER OF DETAIL.

The compact base of the stone-effect surface adds uniformity to the bathroom floor. The precision of the graphics is evident in every detail and faithfully reproduces the tones, contrasts, and irregularities typical of the original material.

Il fondo compatto della superficie effetto pietra dona omogeneità al pavimento del bagno. La precisione della grafica è curata nei minimi particolari e riproduce con fedeltà i toni, i contrasti e le irregolarità tipiche della materia di ispirazione.

La base compacte de la surface effet pierre donne une homogénéité au sol de la salle de bain. La précision du graphisme est soignée dans les moindres détails et reproduit fidèlement les tons, les contrastes et les irrégularités typiques de la matière d'inspiration.

Der gleichmäßige Untergrund des Belags in Steinoptik verleiht dem Badezimmerboden ein einheitliches Aussehen. Die Präzision der Grafik ist bis ins kleinste Detail mit großer Sorgfalt ausgeführt und reproduziert getreu Farbtöne, Kontraste und Unregelmäßigkeiten des als Vorbild dienenden Materials.

El fondo compacto de la superficie con efecto piedra da al suelo del baño un aspecto homogéneo. La precisión de la parte gráfica pone atención a los más mínimos detalles y reproduce fielmente los tonos, los contrastes y las irregularidades propios del material de inspiración.

Плотный фон плитки под камень придает полу в ванной комнате приятную однородность. Ухоженный до мельчайших деталей рисунок с точностью воспроизводит тона, контрасты, неправильность рисунка исходных образцов материала.

atlas concorde



atlas concorde

WALL

Boost Stone **Ivory Mosaico Hex**
25x28,5 cm | 9⁷/₈"x11¹/₄"

SHOWER

Boost Pro **Clay Matte/Matt**
120x278 cm | 47¹/₄"x109¹/₂"

FLOOR

Boost Stone **Ivory Matte/Matt**
120x120 cm | 47¹/₄"x47¹/₄"

Exence **Amber Matte/Matt**
18,5x150 cm | 7¹/₄"x59"

ATLAS CONCORDE — Boost Stone

MOSAICO HEX ENRICHES THE SURFACES OF THE COLLECTION WITH A PATTERN OF HEXAGONAL TILES. WITH ITS SOFT TONES IT ENVELOPS THE SURFACE OF THE BATHROOM WALL, HEIGHTENING THE FEELING OF COMFORT.

IL MOSAICO HEX ARRICCHISCE LE SUPERFICI DELLA COLLEZIONE CON UNA TRAMA DI TESSERE ESAGONALI. CON LE SUE TONALITÀ MORBIDE AVVOLGE LA SUPERFICIE DELLA PARETE DEL BAGNO, ESALTANDO LA SENSAZIONE DI COMFORT.

LA MOSAÏQUE HEX ENRICHIT LES SURFACES DE LA COLLECTION AVEC UNE TEXTURE DE CARREAUX HEXAGONAUX. AVEC SES TEINTES DOUCES, ELLE ENVELOPPE LA SURFACE DU MUR DE LA SALLE DE BAIN, AMÉLIORANT LA SENSATION DE CONFORT.

DAS MOSAIK HEX BEREICHERT DIE KOLLEKTION MIT SEINEN SECHSECKIGEN MOSAIKSTEINCHEN. MIT SEINEN WEICHEN FARBTÖNEN KLEIDET ES DIE WAND IM BAD UND STEIGERT DIE EMPFINDUNG VON ECHTEM KOMFORT.

EL MOSAICO HEX ENRIQUECE LAS SUPERFICIES DE LA COLECCIÓN CON UNA TRAMA DE AZULEJOS HEXAGONALES. CON SUS SUAVES TONOS, ENVUELVE LA SUPERFICIE DE LA PARED DEL BAÑO, AUMENTANDO LA SENSACIÓN DE CONFORT.

МОЗАИКА HEX ОБОГАЩАЕТ ПОВЕРХНОСТИ УЗОРОМ ИЗ ШЕСТИУГОЛЬНЫХ ЭЛЕМЕНТОВ. ЕЕ МЯГКИЕ ТОНА ОКУТЫВАЮТ СТЕНЫ ВАННОЙ, УСИЛИВАЯ ОЩУЩЕНИЕ УЮТА.



74

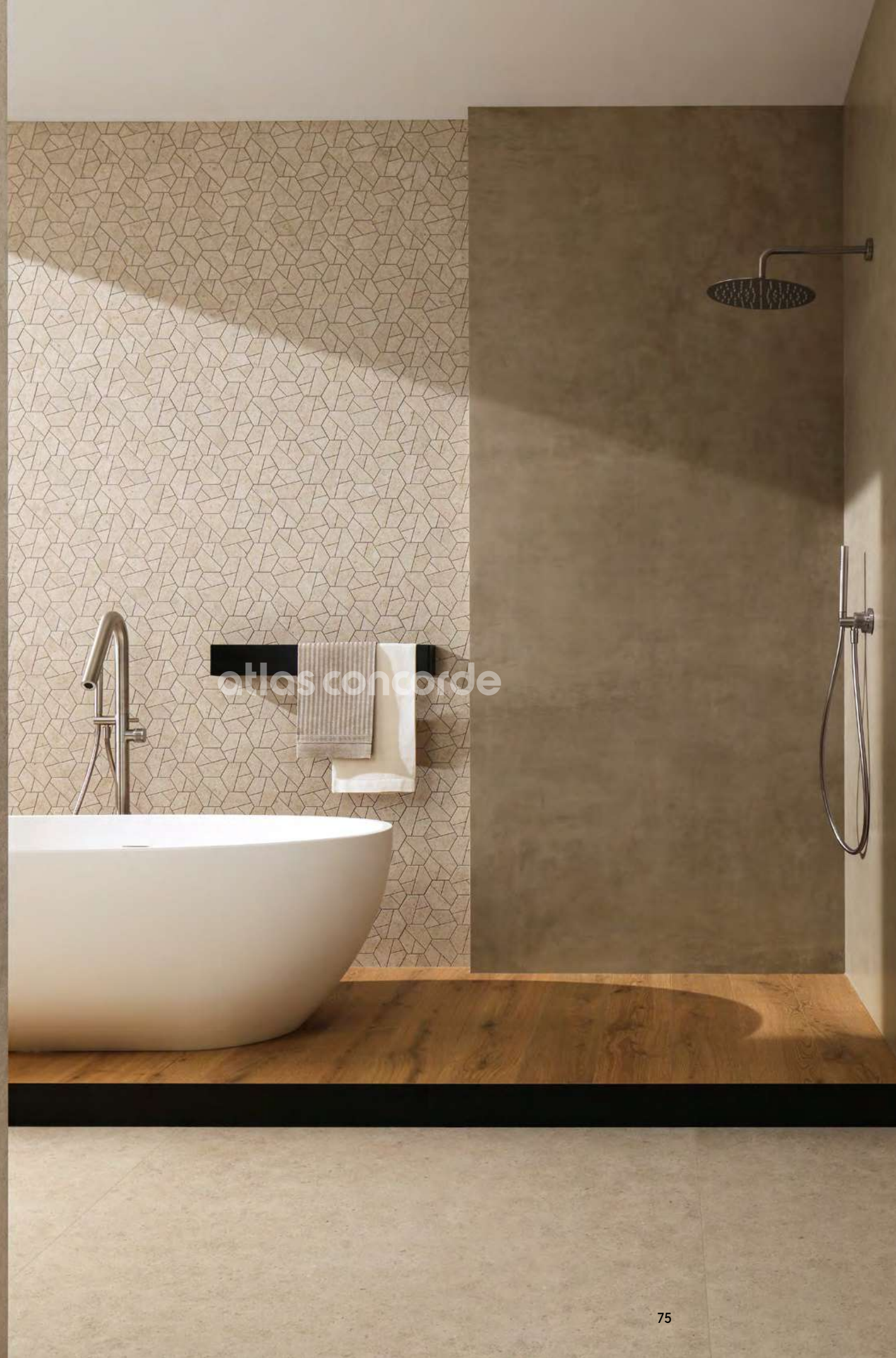

atlas concorde

75



atlas concorde

WALL
Boost Stone Ivory Matte/Matt
60x120 cm | 23 5/8" x 47 1/4"

BOOST STONE OFFERS DESIGNERS THE POSSIBILITY OF CREATING STONE-EFFECT WASHBASINS COORDINATED WITH ALL THE SURFACES OF THE ENVIRONMENT, COMBINING BEAUTY AND SUPERIOR PERFORMANCE IN EVERY SITUATION.

BOOST STONE OFFRE AI PROGETTISTI LA POSSIBILITÀ DI REALIZZARE LAVABI EFFETTO PIETRA COORDINATI A TUTTE LE SUPERFICI DELL'AMBIENTE, CONIUGANDO BELLEZZA E PERFORMANCE ELEVATE IN OGNI SITUAZIONE.

BOOST STONE OFFRE AUX DESIGNERS LA POSSIBILITÉ DE CRÉER DES LAVABOS EFFET PIERRE COORDONNÉS AVEC TOUTES LES SURFACES DE L'ENVIRONNEMENT, ALLIANT BEAUTÉ ET HAUTE PERFORMANCE DANS TOUTES LES SITUATIONS.

BOOST STONE BIETET DEM PLANER DIE MÖGLICHKEIT, WASCHBECKEN MIT STEINOPTIK AUF ALLE OBERFLÄCHEN DES RAUMS ABZUSTIMMEN UND DAMIT GROSSE SCHÖNHEIT UND LEISTUNGEN ZU VEREINEN.

BOOST STONE OFRECE A LOS DISEÑADORES LA POSIBILIDAD DE CREAR LAVABOS DE EFECTO PIEDRA COMBINADOS CON TODAS LAS SUPERFICIES DEL AMBIENTE DE MANERA TAL DE REUNIR LA BELLEZA Y UN ALTO RENDIMIENTO EN CADA CASO.

BOOST STONE ПРЕДОСТАВЛЯЕТ ДИЗАЙНЕРАМ ВОЗМОЖНОСТЬ ВЫБИРАТЬ УМЫВАЛЬНИКИ С ТОЙ ЖЕ ФАКТУРОЙ КАМНЯ, КОТОРАЯ ПОКРЫВАЕТ ОСТАЛЬНЫЕ ПОВЕРХНОСТИ ИНТЕРЬЕРА, СОЧЕТАЯ КРАСОТУ И ВЫСОКИЕ ЭКСПЛУАТАЦИОННЫЕ СВОЙСТВА.



WASHBASIN
Boost Stone Ivory Matte/Matt

TOP/SHELFS
Boost Pro Clay Matte/Matt

APPEALING TEXTURE.

INDOOR

FLOOR

Boost Stone **Ivory** Matte/Matt
120x120 cm | 47¹/₄"x47¹/₄"

Exence **Amber** Matte/Matt
18,5x150 cm | 7¹/₄"x59"

WALL

Boost Stone **Ivory** Matte/Matt
60x120 cm | 23⁵/₈"x47¹/₄"

SHOWER

Boost Stone **Ivory Mosaico Hex**
25x28,5 cm | 9⁷/₈"x11¹/₄"

Boost Pro **Clay** Matte/Matt
120x278 cm | 47¹/₄"x109¹/₂"

FURNITURE

WASHBASIN

Boost Stone **Ivory** Matte/Matt

TOP/SHELFS

Boost Pro **Clay** Matte/Matt





NATURAL SUSPENSION.

The 9 mm floor formats are available in a matte finish that reproduces the natural vibrancy of stone. The tile reinterprets the opacity and pleasantness of the original material without altering its non-slip surface or compromising its ease of cleaning.

I formati da pavimento a 9 mm sono disponibili nella finitura matt che ripropone la naturale matericità della pietra. La superficie reinterpreta l'opacità e la gradevolezza della materia di ispirazione, senza alterare la resistenza allo scivolamento o compromettere la facilità di pulizia.

Les formats de sol de 9 mm sont disponibles dans la finition mate qui repropose le mouvement naturel de la pierre. La surface réinterprète l'opacité et le confort du matériau d'inspiration, sans altérer la résistance au glissement ni compromettre la facilité de nettoyage.

Die 9 mm starken Bodenformate sind mit einer matten Oberfläche erhältlich, die die natürliche Beschaffenheit des Steins wiedergibt. Der Belag interpretiert die Opazität und den Charme des als Vorbild dienenden Materials, ohne deswegen weniger rutschfest oder reinigungsfreundlich zu sein.

Los tamaños de pavimento de 9 mm están disponibles en el acabado mate que vuelve a proponer la motricidad natural de la piedra. La superficie reinterpreta la opacidad y la belleza del material de inspiración sin alterar su carácter antideslizante ni comprometer la facilidad de limpieza.

Напольные форматы толщиной 9 мм доступны в матовом варианте поверхности, как у природного камня. При этом приятная фактура плиток препятствует скольжению и проста в уходе.

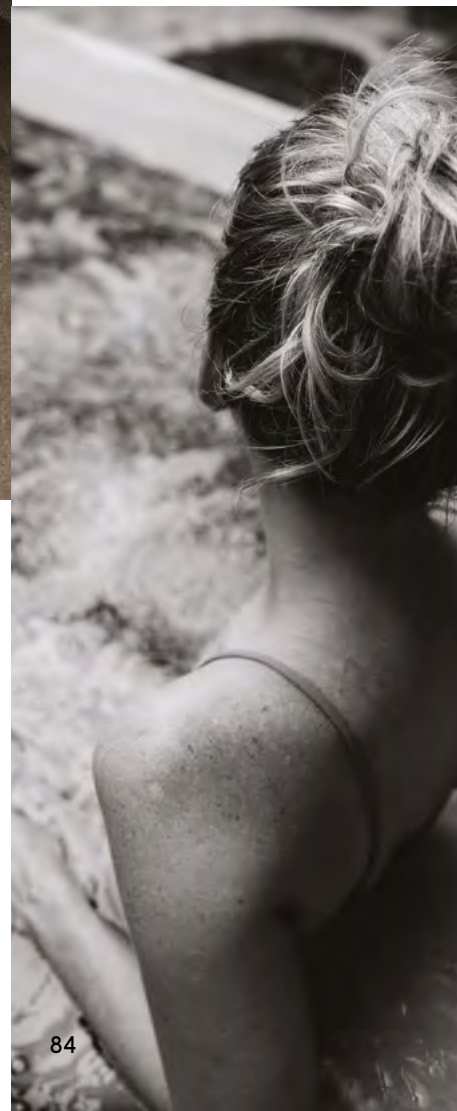

INDOOR

FLOOR
 Boost Stone **Taupe** Matte/Matt
 120x120 cm | 47¹/₄"x47¹/₄"

WALL
 Boost Stone **Ivory** Matte/Matt
 120x278 cm | 47¹/₄"x109¹/₂"

FURNITURE

BATHTUB
 Boost Stone **Ivory** Matte/Matt

ATLAS CONCORDE — Boost Stone



PORCELAIN TILES ARE A SOLUTION SUITABLE FOR ALL BATHROOM SURFACES, FROM FLOORS TO WALLS AND WASHBASINS. THEY'RE EASY TO CLEAN, WATERPROOF, RESISTANT TO STAINS AND ABRASIONS, AND PREVENT THE FORMATION OF GERMS AND BACTERIA.

IL GRES PORCELLANATO È UNA SOLUZIONE ADATTA A TUTTE LE SUPERFICI DEL BAGNO, DAL PAVIMENTO FINO ALLE PARETI E AI LAVABI. SI PULISCE FACILMENTE, È IMPERMEABILE, RESISTE A MACCHIE E ABRASIONI E PREVIENE LA FORMAZIONE DI GERMI E BATTERI.

LE GRÈS CÉRAMÉ EST UNE SOLUTION ADAPTÉE À TOUTES LES SURFACES DE SALLE DE BAIN, DU SOL AUX MURS ET AUX LAVABOS. IL SE NETTOIE FACILEMENT, EST IMPERMÉABLE, RÉSISTE AUX TACHES ET À L'ABRASION ET PRÉVIENT LA FORMATION DE GERMES ET DE BACTÉRIES.

FEINSTEINZEUG EIGNET SICH FÜR ALLE OBERFLÄCHEN IM BAD: VOM BODEN BIS ZU DEN WÄNDEN UND WASCHBECKEN. ES IST EINFACH ZU REINIGEN, UN DURCHLÄSSIG, FLECKEN- UND ABRIEBBESTÄNDIG UND HEMMT DIE BILDUNG VON KEIMEN UND BAKTERIEN.

EL GRES PORCELÁNICO ES ADECUADO PARA TODAS LAS SUPERFICIES DEL BAÑO, DESDE EL PAVIMENTO HASTA LAS PAREDES Y LOS LAVABOS. ES FÁCIL DE LIMPIAR, IMPERMEABLE, RESISTENTE A LAS MANCHAS Y ABRASIONES Y EVITA EL CRECIMIENTO DE GÉRMINES Y BACTERIAS.

КЕРАМОГРАНИТ - ИДЕАЛЬНОЕ РЕШЕНИЕ ДЛЯ ВСЕХ ПОВЕРХНОСТЕЙ ВАННОЙ, ОТ ПОЛОВ И СТЕН ДО УМЫВАЛЬНИКОВ. ОН ЛЕГКО ЧИСТИТСЯ, НЕПРОНИЦАЕМ ДЛЯ ВОДЫ И ВЛАГИ, УСТОЙЧИВ К ПЯТНАМ И ИЗНОСУ, ПРЕПЯТСТВУЕТ ОБРАЗОВАНИЮ МИКРОБОВ И БАКТЕРИЙ.



FLOOR
Boost Stone **Taupe** Matte/Matt
120x120 cm | 47 1/4" x 47 1/4"

WALL
Boost Stone **Clay** Matte/Matt
120x278 cm | 47 1/4" x 109 1/2"

Boost Stone **Ivory** Matte/Matt
120x278 cm | 47 1/4" x 109 1/2"

WASHBASIN, TOP/SHELF
Boost Stone **Ivory** Matte/Matt



INDOOR

FLOOR
Boost Stone **Taupe** Matte/Matt
120x120 cm | 47 1/4" x 47 1/4"

WALL
Boost Stone **Clay** Matte/Matt
120x278 cm | 47 1/4" x 109 1/2"

Boost Stone **Ivory** Matte/Matt
120x278 cm | 47 1/4" x 109 1/2"

FURNITURE

WASHBASIN, TOP/SHELF / BATHTUB
Boost Stone **Ivory** Matte/Matt

PERFORMANCE FOR WELLNESS.





REFINED HARMONY.

The contrast of light shades on the walls and dark tones on the floor highlights the volumes in the room. The grains of the stone-effect texture stand out for their uniqueness and give the space a refined appearance.

L'accostamento delle sfumature chiare del rivestimento a quelle scure del pavimento evidenzia i volumi con un gioco di contrasti. I grani della texture effetto pietra risaltano per la loro unicità e conferiscono allo spazio un aspetto ricercato.

L'association des tons clairs du revêtement avec les tons foncés du sol met en valeur les volumes par un jeu de contrastes. Les grains de la texture effet pierre se distinguent par leur caractère unique et donnent à l'espace un aspect raffiné.

Die Kombination der hellen Wandverkleidung mit dem dunklen Bodenbelag unterstreicht die Volumen in einem Spiel aus Kontrasten. Die Körner der Steinoptik-Textur heben sich durch ihre Einzigartigkeit ab und verleihen dem Raum ein elegantes Aussehen.

La combinación de los tonos claros del revestimiento con los tonos oscuros del pavimento resaltan los volúmenes con un juego de contrastes. Las vetas de la textura con efecto piedra se destacan por su singularidad y crean un aspecto refinado.

Сочетание светлых тонов стен и темных оттенков полов подчеркивает объемы элегантной игрой контрастов. Зернистый рисунок камня уникален и придает интерьеру изысканный вид.



INDEX

OVERVIEW

SPACES

RANGE

TECH. SPECS

INDOOR

FLOOR

Boost Stone **Smoke** Matte/Matt
120x120 cm | 47¹/₄"x47¹/₄"

WALL

Boost **White** Matte/Matt
120x278 cm | 47¹/₄"x109¹/₂"

FURNITURE

WASHBASIN

Boost Stone **Smoke** Matte/Matt

ATLAS CONCORDE — Boost Stone





atlas concorde

THE CUBE MOSAIC FEATURES A VARIETY OF COLORS AND GEOMETRIC SHAPES, EXPLOITING DIFFERENT SURFACE EFFECTS AND TEXTURES. IT CAN BE LAID ON THE WALL OR FLOOR, CREATING DIFFERENT INSTALLATION LAYOUTS WITH A STRONG VISUAL IMPACT.

IL MOSAICO CUBE COSTRUISCE VARIAZIONI GEOMETRICHE E CROMATICHE, SFRUTTANDO EFFETTI DI SUPERFICIE E TEXTURE DIFFERENTI. PUÒ ESSERE POSATO A PARETE O PAVIMENTO, CREANDO DIFFERENTI SCHEMI DI POSA DAL FORTE IMPATTO VISIVO.

LA MOSAÏQUE CUBE CONSTITUT DES VARIATIONS GÉOMÉTRIQUES ET CHROMATIQUES, EXPLOITANT DIFFÉRENTS EFFETS DE SURFACE ET TEXTURES. IL PEUT ÊTRE POSÉ AU MUR OU AU SOL, CRÉANT DIFFÉRENTS MOTIFS DE POSE AVEC UN FORT IMPACT VISUEL.

DAS MOSAIK CUBE KONSTRUIERT AUS UNTERSCHIEDLICHEN OBERFLÄCHENEFFEKTEN UND TEXTUREN GEOMETRISCHE UND FARBliche VARIATIONEN. ES KANN AN WAND UND BODEN VERLEGT WERDEN, MIT VERSCHIEDENEN, STETS OPTISCH EFFEKTVOLLEN VERLEGEMUSTERN.

EL MOSAICO CUBE CREA VARIACIONES GEOMÉTRICAS Y CROMÁTICAS GRACIAS A LOS DISTINTOS EFECTOS DE LAS SUPERFICIES Y LAS TEXTURAS. SE PUEDE COLOCAR EN LAS PAREDES O EN EL PAVIMENTO CREANDO DIFERENTES PATRONES DE COLOCACIÓN CON UN FUERTE IMPACTO VISUAL.

МОЗАИКА CUBE ОБРАЗУЕТ ГЕОМЕТРИЧЕСКИЕ И ЦВЕТОВЫЕ ВАРИАЦИИ, ИГРАЯ НА РАЗНЫХ РИСУНКАХ И ФАКТУРАХ. МОЖЕТ БЫТЬ УЛОЖЕНА НА ПОЛЫ ИЛИ СТЕНЫ В РАЗНЫХ, НО ВСЕГДА ЭФФЕКТНЫХ СХЕМАХ УКЛАДКИ.



atlas concorde

FLOOR
Boost Stone **Smoke** Matte/Matt
120x120 cm | 47¹/₄"x47¹/₄"

BÄHTTUB AREA
Boost Stone **Mosaico Cube Cold**
30x30 cm | 11³/₄"x11³/₄"

Boost Stone **Smoke** Matte/Matt
120x278 cm | 47¹/₄"x109¹/₂"

Boost **White** Matte/Matt
120x278 cm | 47¹/₄"x109¹/₂"



INDOOR

FLOOR

Boost Stone **Smoke** Matte/Matt
120x120 cm | 47¹/₄"x47¹/₄"

WALL

Boost Stone **Smoke** Matte/Matt
120x278 cm | 47¹/₄"x109¹/₂"

Boost **White** Matte/Matt

120x278 cm | 47¹/₄"x109¹/₂"

BATHTUB AREA

Boost Stone **Mosaico Cube Cold**
30x30 cm | 11³/₄"x11³/₄"

FURNITURE

WASHBASIN

Boost Stone **Smoke** Matte/Matt

ATLAS CONCORDE — Boost Stone





WELCOMING TEXTURE.

atlasconcorde

The 120x278 format is ideal for cladding walls all the way to the ceiling in a large commercial space and reducing the number of joints. The combination of the stone effect with other surfaces, such as the concrete or marble effect, generates a pleasant contrast of materials and styles.

Il formato 120x278 è ideale per rivestire pareti a tutta altezza in un ampio spazio commerciale e ridurre il numero delle fughe. L'abbinabilità dell'effetto pietra ad altre superfici, come l'effetto cemento o marmo, genera un piacevole contrasto materico e stilistico.

Le format 120x278 est idéal pour couvrir les murs toute hauteur d'un grand espace commercial et réduire le nombre de joints. La combinaison de l'effet pierre avec d'autres surfaces, telles que l'effet béton ou marbre, génère un agréable contraste de matière et de style.

Das Format 120x278 ist ideal, um Wände in einem großen Verkaufslokal raumhoch zu verkleiden und die Anzahl der Fugen zu reduzieren. Die Kombinierbarkeit der Steinoptik mit anderen Oberflächen wie Zement- oder Marmoroptik erzeugt einen ansprechenden stofflich-stilistischen Kontrast.

El tamaño 120x278 es ideal para cubrir paredes de altura completa en un gran espacio comercial y reducir el número de juntas. La posibilidad de combinar el efecto piedra con otras superficies, como el cemento o el mármol, crea un agradable contraste material y estilístico.

Форматом 120x278 можно покрыть стены торгового интерьера на всю высоту с вытекающей из этого минимизацией количества швов. Сочетание фактуры камня с другими рисунками, например, мрамора и цемента, рождает приятный контраст материалов и стилей.



atlas concorde



atlas concorde

CONTEMPORARY CONNECTIONS .

FLOOR
Boost Stone **Ivory** Matte/Matt
120x120 cm | 47¹/₄"x47¹/₄"

WALL
Boost Stone **Ivory** Matte/Matt
120x278 cm | 47¹/₄"x109¹/₂"



THE SURFACES OF BOOST STONE ARE DESIGNED TO INTERACT WITH ALL THE PRODUCTS OF BOOST WORLD, COMBINING THE NATURAL VIGOR OF THE STONE EFFECT WITH THE OTHER INSPIRATIONS OF THIS CROSS-CUTTING PROJECT.

LE SUPERFICI DI BOOST STONE SONO STUDIATE PER DIALOGARE CON TUTTI I PRODOTTI DI BOOST WORLD, COMBINANDO IL VIGORE NATURALE DELL'EFFETTO PIETRA ALLE ALTRE ISPIRAZIONI DI QUESTO PROGETTO TRASVERSALE.

LES SURFACES DE BOOST STONE SONT CONÇUES POUR DIALOGUER AVEC TOUS LES PRODUITS DE BOOST WORLD, ALLIANT LA VIGUEUR NATURELLE DE L'EFFET PIERRE AUX AUTRES INSPIRATIONS DE CE PROJET TRANSVERSAL.

DIE OBERFLÄCHEN VON BOOST STONE SIND DAFÜR KONZIPIERT, MIT ALLEN BOOST WORLD-PRODUKTEN ZU DIALOGIEREN, SO DASS SICH DIE NATÜRLICHE KRAFT DER STEINOPTIK MIT DEN ANDEREN INSPIRATIONEN DIESES BREIT ANGELEGTEN PROJEKTS VERBINDET.

LAS SUPERFICIES DE BOOST STONE SE HAN CREADO PARA DIALOGAR CON TODOS LOS PRODUCTOS DE BOOST WORLD, COMBINANDO EL VIGOR NATURAL DEL EFECTO PIEDRA CON LAS DEMÁS INSPIRACIONES DE ESTE PROYECTO TRANSVERSAL.

ПЛИТКИ BOOST STONE СПРОЕКТИРОВАНЫ ТАКИМ ОБРАЗОМ, ЧТОБЫ СОЧЕТАТЬСЯ СО ВСЕМИ ИЗДЕЛИЯМИ ЛИНЕЙКИ BOOST WORLD: ПОЛУЧАЕТСЯ ИНТЕРЕСНЫЙ КОНТРАСТ СУРОВОЙ ФАКТУРЫ КАМНЯ С ДРУГИМИ ФАКТУРАМИ ЭТОГО КОМПЛЕКСНОГО ПРОЕКТА.



FLOOR
Boost Stone **Ivory** Matte/Matt
120x120 cm | 47¹/₄"x47¹/₄"

WALL
Boost Stone **Ivory** Matte/Matt
120x278 cm | 47¹/₄"x109¹/₂"

Boost Natural **Coral** Matte/Matt
120x278 cm | 47¹/₄"x109¹/₂"



INDOOR

FLOOR

Boost Stone **Ivory** Matte/Matt
120x120 cm | 47¹/₄"x47¹/₄"

Boost Stone **Ivory Mosaico Hex**
25x28,5 cm | 9⁷/₈"x11¹/₄"

WALL

Boost Stone **Ivory** Matte/Matt
120x278 cm | 47¹/₄"x109¹/₂"

Boost Natural **Coral** Matte/Matt
120x278 cm | 47¹/₄"x109¹/₂"

FURNITURE

SHELFS

Boost Stone **Ivory** Matte/Matt
120x278 cm | 47¹/₄"x109¹/₂"

COUNTERS

Marvel Shine **Calacatta Delicato** Polished/Lappato
120x278 cm | 47¹/₄"x109¹/₂"

BOOST STONE

Porcelain tiles

COLOURED BODY PORCELAIN TILES - RECTIFIED MONOCALIBER

GRES PORCELLANATO COLORATO IN MASSA - RETTIFICATO MONOCALIBRO

Grès cérame coloré dans la masse - Rectifié mono-calibre / Durchgefärbtes Feinsteinzeug - Geschliffen einkalibrig /

Gres porcelánico coloreado en masa - Rectificado monocalibre / Керамический гранит окрашенный в массе - Ретицированный в одном калибре

Destination of use



Matte ± 6 mm



Matte ± 9 mm
Grip ± 9 mm
Textured ± 20 mm

Anti-slip



R9 A Matte ± 6 mm

R10 A+B Matte ± 9 mm

R11 A+B+C Grip ± 9 mm | Textured ± 20 mm



= Thickness

Color-shading

V2 Slight Variation

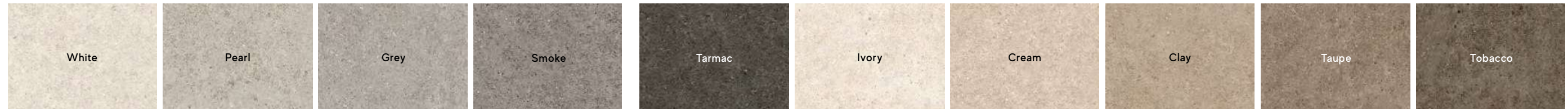

120x278 cm - 47 1/4" x 109 1/2"

± 6 mm

Matte

Matte

Matte

Matte

Matte

Matte

Matte

Matte

Matte

Matte

120x120 cm - 47 1/4" x 47 1/4"

± 9 mm

Matte

Matte

Matte

Matte

Matte

Matte

Matte

Matte

Matte

Matte

60x120 cm - 23 5/8" x 47 1/4"

± 9 mm

Matte

Matte

Matte

Matte

Matte

Matte

Matte

Matte

Matte

Matte

60x60 cm - 23 5/8" x 23 5/8"

± 9 mm

Matte

Matte

Matte

Matte

Matte

Matte

Matte

Matte

Matte

Matte

30x60 cm - 11 3/4" x 23 5/8"

± 9 mm

Matte

Matte

Matte

Matte

Matte

Matte

Matte

Matte

Matte

Matte



Outdoor and Wet Areas

60x120 cm - 23 5/8" x 47 1/4"

± 9 mm

Grip

Grip

Grip

Grip

Grip

Grip

Grip

Grip

Grip

Grip

30x60 cm - 11 3/4" x 23 5/8"

± 9 mm

Grip

Grip

Grip

Grip

Grip

Grip

Grip

Grip

Grip

Grip

120x120 cm - 47 1/4" x 47 1/4"

± 20 mm

Textured

Textured

Textured

Textured

Textured

Textured

Textured

Textured

Textured

Textured

60x120 cm - 23 5/8" x 47 1/4"

± 20 mm

Textured

Textured

Textured

Textured

Textured

Textured

Textured

Textured

Textured

Textured

60x60 cm - 23 5/8" x 23 5/8"

± 20 mm

Textured

Textured

Textured

Textured

Textured

Textured

Textured

Textured

Textured

Textured



Atlas Plan

162x324 cm - 63 3/4" x 127 1/2"

± 12 mm

> Non rectified - non rettificato

Hammered



BOOST STONE
Porcelain tile decors

Boost Stone White Mosaico Hex
 25x28,5 cm - 9⁷/₈"x11¹/₄"



Boost Stone Pearl Mosaico Hex
 25x28,5 cm - 9⁷/₈"x11¹/₄"



Boost Stone Grey Mosaico Hex
 25x28,5 cm - 9⁷/₈"x11¹/₄"



Boost Stone Smoke Mosaico Hex
 25x28,5 cm - 9⁷/₈"x11¹/₄"



Boost Stone Tarmac Mosaico Hex
 25x28,5 cm - 9⁷/₈"x11¹/₄"

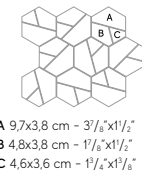

Boost Stone Ivory Mosaico Hex
 25x28,5 cm - 9⁷/₈"x11¹/₄"



Boost Stone Cream Mosaico Hex
 25x28,5 cm - 9⁷/₈"x11¹/₄"



Boost Stone Clay Mosaico Hex
 25x28,5 cm - 9⁷/₈"x11¹/₄"



Boost Stone Taupe Mosaico Hex
 25x28,5 cm - 9⁷/₈"x11¹/₄"



Boost Stone Tobacco Mosaico Hex
 25x28,5 cm - 9⁷/₈"x11¹/₄"



Boost Stone White Mosaico Matt
 30x30 cm - 11³/₄"x11³/₄"

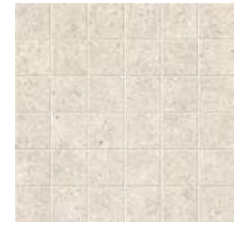

Boost Stone Pearl Mosaico Matt
 30x30 cm - 11³/₄"x11³/₄"



Boost Stone Grey Mosaico Matt
 30x30 cm - 11³/₄"x11³/₄"



Boost Stone Smoke Mosaico Matt
 30x30 cm - 11³/₄"x11³/₄"

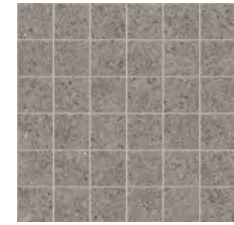

Boost Stone Tarmac Mosaico Matt
 30x30 cm - 11³/₄"x11³/₄"

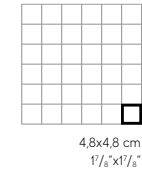
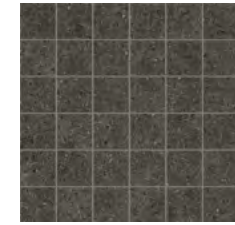

Boost Stone Ivory Mosaico Matt
 30x30 cm - 11³/₄"x11³/₄"



Boost Stone Cream Mosaico Matt
 30x30 cm - 11³/₄"x11³/₄"



Boost Stone Clay Mosaico Matt
 30x30 cm - 11³/₄"x11³/₄"



Boost Stone Taupe Mosaico Matt
 30x30 cm - 11³/₄"x11³/₄"



Boost Stone Tobacco Mosaico Matt
 30x30 cm - 11³/₄"x11³/₄"

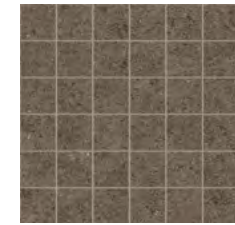

Boost Stone White Mosaico Brick
 30x60 cm - 11³/₄"x23⁵/₈"



Boost Stone Ivory Mosaico Brick
 30x60 cm - 11³/₄"x23⁵/₈"

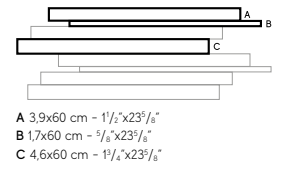

Boost Stone Pearl Mosaico Brick
 30x60 cm - 11³/₄"x23⁵/₈"



Boost Stone Cream Mosaico Brick
 30x60 cm - 11³/₄"x23⁵/₈"



Boost Stone Grey Mosaico Brick
 30x60 cm - 11³/₄"x23⁵/₈"



Boost Stone Clay Mosaico Brick
 30x60 cm - 11³/₄"x23⁵/₈"



Boost Stone Smoke Mosaico Brick
 30x60 cm - 11³/₄"x23⁵/₈"



Boost Stone Taupe Mosaico Brick
 30x60 cm - 11³/₄"x23⁵/₈"



Boost Stone Tarmac Mosaico Brick
 30x60 cm - 11³/₄"x23⁵/₈"



Boost Stone Tobacco Mosaico Brick
 30x60 cm - 11³/₄"x23⁵/₈"



BOOST STONE
Porcelain tile decors

**Boost Stone
 Mosaico Cube Warm**
 30x30 cm - 11³/₄"x11³/₄"



Warm > Boost Stone Cream, Boost Stone Clay, Boost Stone Ivory, Boost Pro Ivory

Laying patterns

Boost Stone Carpet 01
 30x30 cm - 11³/₄"x11³/₄"



Boost Stone Carpet 02
 30x30 cm - 11³/₄"x11³/₄"



Boost Stone Fixed
 30x30 cm - 11³/₄"x11³/₄"



Boost Stone Random
 30x30 cm - 11³/₄"x11³/₄"

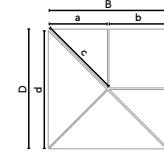

- A 29.8 cm - 11⁷/₁₆"
- a 14.6 cm - 5⁷/₁₆"
- b 14.8 cm - 5⁷/₁₆"
- c 20.8 cm - 8¹/₄"
- D 29.8 cm - 11⁷/₁₆"
- d 29.5 cm - 11⁵/₁₆"

**Boost Stone
 Mosaico Cube Cold**
 30x30 cm - 11³/₄"x11³/₄"



Cold > Boost Stone Smoke, Boost Stone Grey, Boost Stone Pearl, Boost Pearl

Laying patterns

Boost Stone Carpet 01
 30x30 cm - 11³/₄"x11³/₄"



Boost Stone Carpet 02
 30x30 cm - 11³/₄"x11³/₄"



Boost Stone Fixed
 30x30 cm - 11³/₄"x11³/₄"

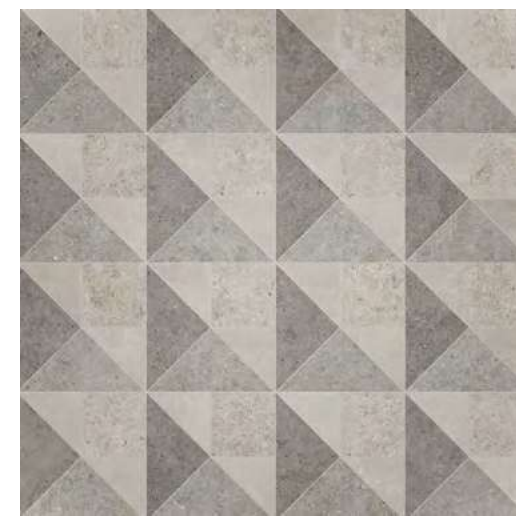

Boost Stone Random
 30x30 cm - 11³/₄"x11³/₄"

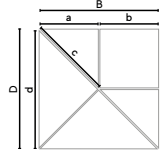

- A 29.8 cm - 11⁷/₁₆"
- a 14.6 cm - 5⁷/₁₆"
- b 14.8 cm - 5⁷/₁₆"
- c 20.8 cm - 8¹/₄"
- D 29.8 cm - 11⁷/₁₆"
- d 29.5 cm - 11⁵/₁₆"

Trim tiles

Indoor trim tiles

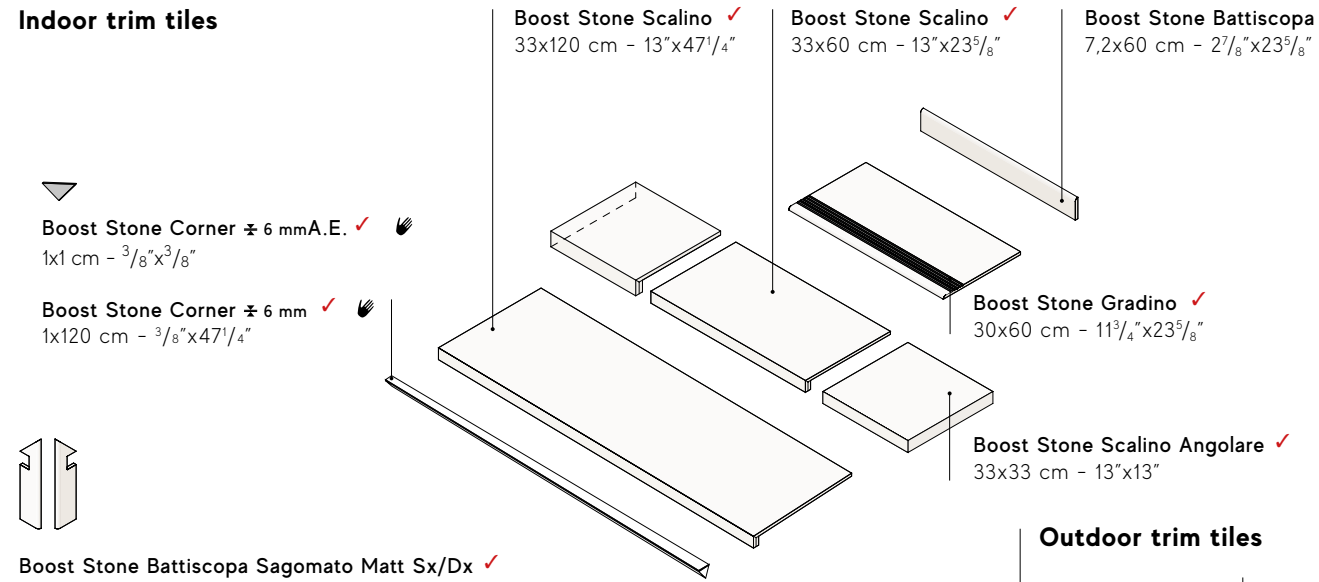

Boost Stone Battiscopa Sagomato Matt Sx/Dx ✓
7,2x30 cm - 2 7/8"x11 3/4"

✓ These parts are supplied to order / I pezzi sono disponibili su ordinazione

Outdoor trim tiles

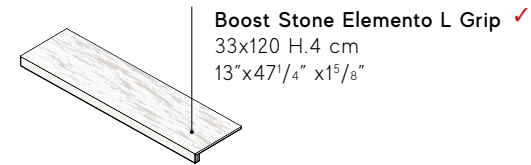

Outdoor trim tiles ± 20 mm

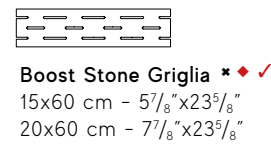
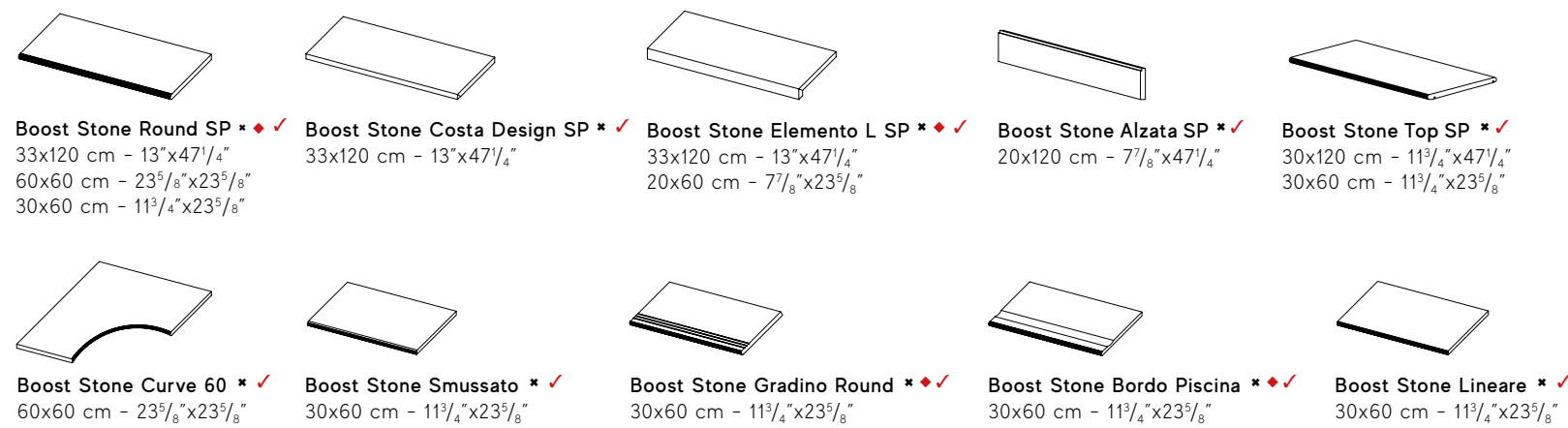

Available in / Disponibile in:

- * White, Cream, Clay, Grey, Smoke, Tarmac
- ✓ These parts are supplied to order / I pezzi sono disponibili su ordinazione
- ♦ Right-left angular elements are available / Sono disponibili gli elementi angolari dx/sx

Porcelain tiles ± 20 mm

For further details on the 20mm thick products, related trim pieces and installation systems - in particular for recommendations and precautions during installation- please refer to the **Outdoor Design** section on the **Atlas Concorde website** or to the **Outdoor Design catalogue**. Per dettagli sul prodotto e sui relativi pezzi speciali in 20mm di spessore, per i sistemi di posa e, in particolare, per raccomandazioni, accorgimenti e precauzioni in fase di posa e progettazione, si raccomanda di prendere visione del catalogo Outdoor Design e della sezione Outdoor Design del sito Atlas Concorde. / Pour plus de renseignements sur le produit, les pièces spéciales de 20mm d'épaisseur et sur les systèmes de pose, ainsi que pour tous conseils et recommandations et précautions d'emploi pendant la pose ou en phase de conception, nous vous recommandons de lire le catalogue Outdoor Design et de consulter la section Outdoor Design sur le site d'Atlas Concorde. / Bitte beachten Sie die detaillierten Informationen zum Produkt und zu den zugehörigen Formteilen in 20mm Stärke, zu den Verlegesystemen sowie vor allem die Empfehlungen, Tipps und bei der Planung und Verlegung zu beachtenden Vorsichtsmaßnahmen, die im Katalog Outdoor Design sowie im Bereich Outdoor Design der Atlas Concorde-Website aufgeführt sind. / Para mayor información sobre el producto y sus relativas piezas especiales de 20mm de grosor, para los sistemas de colocación, y en particular, para las recomendaciones, cautelas y precauciones en la fase de colocación y diseño, se recomienda consultar el catálogo Outdoor Design y la sección Outdoor Design del sitio Atlas Concorde. / Подробнее о плитках и о специальных элементах толщиной 20мм, о системах монтажа, о мерах предосторожности при проектировании и укладке можно узнать в каталоге Outdoor Design и в разделе Outdoor Design на сайте Atlas Concorde.





Note

For information and details relating to codes, packaging and weight it is recommended to refer to the latest pricelist. / Per le informazioni e i dati relativi a codici, imballaggi e pesi occorre sempre consultare l'ultimo listino aggiornato e in vigore. / Pour toutes informations et renseignements concernant les codes, les emballages et les poids, il y a toujours lieu de consulter le dernier tarif en vigueur et mis à jour. / Für Informationen und Daten die den Code, die Verpackung und das Gewicht betreffen bitte die aktuellste Preisliste zugrunde legen. / Para acceder a la información y a los datos relativos a códigos, embalajes y pesos hay que consultar siempre la última lista de precios actualizada y vigente. / Для информации о кодах, упаковках и весе обращайтесь к последнему действующему прайс-листу.

Colors and optical features of the materials illustrated in this catalogue are to be regarded as mere indications. / I colori e le caratteristiche estetiche dei materiali illustrati nel presente catalogo sono da ritenersi puramente indicativi. / Les coloris et les caractéristiques esthétiques des références illustrées dans le catalogue sont donnés à titre purement indicatif. / Die Farben und die ästhetischen Eigenschaften der in diesem Katalog abgebildeten Produkte sind als reine Richtwerte zu betrachten. / Los colores y las características estéticas de los materiales ilustrados en el presente catálogo deben ser considerados como puramente indicativos. / Цвета и эстетические характеристики описанных в настоящем каталоге материалов являются только ориентировочными.

Atlas Concorde reserves the right to modify any product without notice and will not be liable for any direct or indirect damage resulting from such modifications. / Atlas Concorde si riserva di modificare i prodotti senza preavviso, declinando ogni responsabilità su eventuali danni diretti o indiretti derivanti da eventuali modifiche. / Atlas Concorde se réserve le droit de modifier ses produits sans préavis et décline toute responsabilité concernant les éventuels dommages directs ou indirects qui pourraient dériver de ces modifications. / Atlas Concorde behält sich das Recht vor jederzeit und ohne vorherige Ankündigung, die Produkte zu verändern, und lehnt jede Haftung bei direkten oder indirekten Schäden ab, die von diesen Veränderungen herrühren. / Atlas Concorde se reserva el derecho de modificar los productos sin previo aviso, rechaza cualquier responsabilidad sobre eventuales daños directos o indirectos derivados de eventuales modificaciones. / Atlas Concorde оставляет за собой право изменять характеристики изделий без предварительного уведомления, отклоняя при этом любую ответственность за прямые или косвенные убытки, возникшие в результате изменений.

THANKS TO

GERVASONI
1882

www.gervasoni1882.it



www.zilioaldo.it



www.plinioilgiovane.com



www.monicamasiero.it



www.ivvnet.it

SOVET
ITALIA

www.sovet.com



www.zavaluce.it



www.ilgiardinodicorten.it



www.memedesign.it



1998 | TORINO | ITALIA

www.lopficio.it



www.labottegadicasa.com



www.oway.it

bosa ★

www.bosatrade.com

Axolight

www.axolight.it

Tisettanta elam
CERAMICHE PER HOME kitchen system

www.tisettanta.it

Coloured body porcelain tiles - Rectified monocaliber



Compliant with standards EN 14411 annex G group BLa
Compliant with standards ISO 13006 annex G group BLa
Conforme alla norma EN 14411 Appendice G gruppo BLa
Conforme alla norma ISO 13006 Appendice G gruppo BLa

Gres porcellanato colorato in massa - Rettificato monocalibro

120x278 cm - 47¹/₄"x109¹/₂" ± 6 mm
120x120 cm - 47¹/₄"x47¹/₄"
60x120 cm - 23³/₈"x47¹/₄"
60x60 cm - 23³/₈"x23³/₈"
30x60 cm - 11³/₄"x23³/₈"

± 9 mm
± 9 mm
± 9 mm
± 9 mm
± 9 mm
120x120 cm - 47¹/₄"x47¹/₄"
60x120 cm - 23³/₈"x47¹/₄"
60x60 cm - 23³/₈"x23³/₈"
± 9 mm
± 9 mm
± 9 mm
± 9 mm

Technical features Caratteristiche tecniche	Test Method Metodo di prova	Requirements for nominal size N / Requisiti per dimensione nominale N		
		7 cm ≤ N < 15 cm (mm)	N ≥ 15 cm (%)	N ≥ 15 cm (mm)
Length and width Lunghezza e larghezza		± 0,9 (*) Non-rect. ± 0,4 (*) Rect.	± 0,6 (*) Non-rect. ± 0,3 (*) Rect.	± 2,0 (*) Non-rect. ± 1,0 (*) Rect.
Thickness Spessore		± 0,5 (**)	± 5 (***)	± 0,5 (**)
Straightness of sides Rettilineità degli spigoli	ISO 10545-2	± 0,8 (***) Non-rect. ± 0,4 (***) Rect.	± 0,5 (***) Non-rect. ± 0,3 (***) Rect.	± 1,5 (***) Non-rect. ± 0,8 (***) Rect.
Rectangularity (Measurement only on short edges when L/l ≥ 3) Ortogonalità (Misurazione da condurre solo sui lati corti quando L/l ≥ 3)		± 0,8 (***) Non-rect. ± 0,4 (***) Rect.	± 0,5 (***) Non-rect. ± 0,3 (***) Rect.	± 2,0 (***) Non-rect. ± 1,5 (***) Rect.
Surface flatness Planarità	ISO 10545-2	c.c. ± 0,8 Non-rect. c.c. ± 0,6 Rect. e.c. ± 0,8 Non-rect. e.c. ± 0,6 Rect. w. ± 0,8 Non-rect. w. ± 0,4 Rect.	c.c. ± 0,5 Non-rect. c.c. ± 0,4 Rect. e.c. ± 0,5 Non-rect. e.c. ± 0,4 Rect. w. ± 0,5 Non-rect. w. ± 0,4 Rect.	c.c. ± 2,0 Non-rect. c.c. ± 1,8 Rect. e.c. ± 2,0 Non-rect. e.c. ± 1,8 Rect. w. ± 2,0 Non-rect. w. ± 1,8 Rect.
Water absorption (in% by mass) Massa d'acqua assorbita (come % della massa)	ISO 10545-3 ASTM C373-18	E _p ≤ 0,5% Individual Maximum 0,6% E _v ≤ 0,5% Valore massimo singolo 0,6% Requirement ANSI A137.1-2017 Water absorption max ≤ 0,5%		
Breaking strength Sforzo di rottura	ISO 10545-4	S ≥ 700N (for thickness < 7,5 mm - per spessore < 7,5 mm) S ≥ 1300N (for thickness ≥ 7,5 mm - per spessore ≥ 7,5 mm)		
Modulus of rupture Resistenza alla flessione		R ≥ 35 N/mm ²		
Bending strength and breaking load Resistenza a flessione e al carico di rottura (4)(5)	EN 1339 Annex F	-		
Impact resistance, as coefficient of restitution Resistenza all'impatto, espresso come coefficiente di restituzione	ISO 10545-5	Declared value Valore dichiarato		
Mohs hardness Durezza Mohs	EN 101	-		
Resistance to deep abrasion of unglazed tiles (removed volume) Resistenza all'abrasione profonda delle piastrelle non smaltate (volume materiale asportato)	ISO 10545-6	≤ 175 mm ³		
Coefficient of thermal linear expansion Coefficiente di dilatazione termica lineare	ISO 10545-8	Declared value Valore dichiarato		
Thermal shock resistance Resistenza agli sbalzi termici	ISO 10545-9	Pass according to EN ISO 10545-1 Test superato in accordo con ISO 10545-1		
Moisture expansion (in mm/m) Dilatazione all'umidità (in mm/m)	ISO 10545-10	Declared value Valore dichiarato		
Frost resistance Resistenza al gelo	ISO 10545-12	Pass according to EN ISO 10545-1 Test superato in accordo con ISO 10545-1		
Bond strength/adhesion for improved cementitious adhesives Adesione a trazione con adesivi cementizi migliorati	EN 1348	Declared value Valore dichiarato		
Reaction to fire Reazione al fuoco	-	Class A1 or A1 _s Classe A1 oppure A1 _s		
Resistance to household chemicals and swimming pool salts Resistenza ai prodotti chimici di uso domestico e agli additivi per piscina		Minimum Class B Classe minima B		
Resistance to low concentrations of acids and alkalis Resistenza a basse concentrazioni di acidi e alcali	ISO 10545-13	Declared Class Classe dichiarata		
Resistance to high concentrations of acids and alkalis Resistenza ad alte concentrazioni di acidi e alcali		Declared Class Classe dichiarata		
Resistance to staining, for unglazed tiles Resistenza alle macchie per piastrelle non smaltate	ISO 10545-14	Declared Class Classe dichiarata		
Shod Ramp Test Metodo della rampa "calzato"	DIN 51130	Declared value Valore dichiarato		
Barefoot Ramp Test Metodo della rampa a piedi nudi	DIN 51097	Declared value Valore dichiarato		
Pendulum Friction Test Metodo del Pendolo	BS 7976	PTV ≥ 36 classifies the surface as "low slip risk"		
	AS 4586	Declared Classification of the new pedestrian surface materials according to the Pendulum Test		
Coefficient of friction (COF) Coefficiente di attrito	UNE-ENV 12633	Declared value Valore dichiarato		
	B.C.R.A. Rep. CEC/81	D. M. 236/89 del 14/06/89 μ > 0,40 per elemento scivolante cuoio su pavimentazione asciutta μ > 0,40 per elemento scivolante gomma dura su pavimentazione bagnata		
Dynamic coefficient of friction (DCOF) Coefficiente di attrito dinamico	ANSI A137.1	ANSI A.137.1-2017 Requires a minimum value of 0.42 for level interior space expected to be walked upon when wet. (3)		

(*) The permissible deviation, in % or mm, of the average size for each tile (2 or 4 sides) from work size (WS). Deviazione ammissibile, in % oppure mm, della dimensione media di ogni piastrella (2 oppure 4 lati) dalla dimensione di fabbricazione (WS).
(**) The permissible deviation, in % or mm, of the average thickness for each tile from the work size thickness (WS). Deviazione ammissibile, in % oppure mm, dello spessore medio di ogni piastrella dallo spessore riportato nella dimensione di fabbricazione (WS).
(***) The maximum permissible deviation from straightness, in % or mm, related to the corresponding work sizes (WS). Deviazione massima ammissibile di rettilineità, in % oppure mm, in rapporto alle dimensioni di fabbricazione (WS) corrispondenti.
(****) The maximum permissible deviation from rectangularity, in % or mm, related to the corresponding work sizes (WS). Deviazione massima ammissibile di rettitudine, in % oppure mm, in rapporto alle dimensioni di fabbricazione (WS) corrispondenti.
(v) The maximum permissible deviation from centre curvature, in % or mm, related to diagonal calculated from the work sizes (WS). Deviazione massima ammissibile della curvatura del centro, in % oppure mm, in rapporto alla diagonale calcolata secondo le dimensioni di fabbricazione (WS).
(w) The maximum permissible deviation from warpage, in % or mm, related to diagonal calculated from the work sizes (WS). Deviazione massima ammissibile dello sverglamento, in % oppure mm, in rapporto alla diagonale calcolata secondo le dimensioni di fabbricazione (WS).
(1) Determination of slip resistance of pedestrian surfaces; it does not cover sports surfaces and road surfaces for vehicles (skid resistance). Determinazione della resistenza allo scivolamento delle superfici pedonabili; non si applica alle pavimentazioni sportive ed alle pavimentazioni stradali veicolari.
(2) Anti-slip performance is guaranteed at the time of delivery of the product. Le prestazioni anti-slip vengono garantite al momento della consegna del prodotto.
(3) However, tiles with a DCOF of 0.42 or greater are not necessarily suitable for all projects. The specifier shall determine tiles appropriate for specific project conditions, considering by way of example, but not in limitation, type of use, traffic, expected contaminants, expected maintenance, expected wear, and manufacturers' guidelines and recommendations.
(4) For further details, please refer to outdoor design general catalogue. Per maggiori informazioni riferirsi al catalogo generale Outdoor Design.
(5) Only for products with 20 mm thickness. Solo per prodotti a 20mm di spessore.
(e) PTV ≥ 36 Wet on demand / su richiesta
(ee) P3 on demand / su richiesta
(eee) C2 on demand / su richiesta

Porcelain tiles

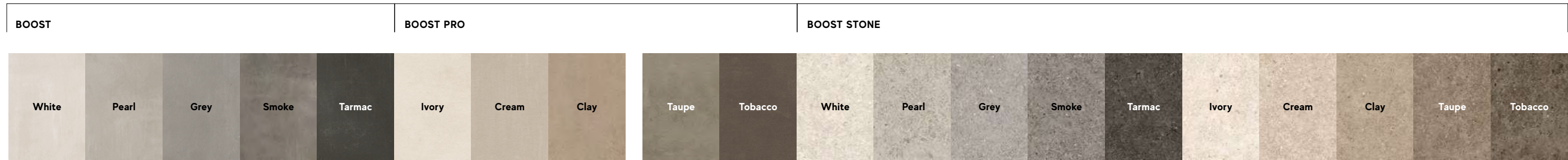

Size	Thickness	Finish	Boost	Boost Pro	Boost Stone
160x320 cm - 63"x126"	± 6 mm	Matte	Matte	Matte	Matte
160x160 cm - 63"x63"	± 6 mm	Matte	Matte	Matte	Matte
120x278 cm - 47 1/4"x109 1/2"	± 6 mm	Matte	Matte	Matte	Matte
120x240 cm - 47 1/4"x94 1/2"	± 9 mm	Matte	Matte	Matte	Matte
120x120 cm - 47 1/4"x47 1/4"	± 6 mm	Matte	Matte	Matte	Matte
	± 9 mm	Matte	Matte	Matte	Matte
75x150 cm - 29 1/2"x59"	± 9 mm	Matte	Matte	Matte	Matte
60x120 cm - 23 5/8"x47 1/4"	± 9 mm	Matte	Matte	Matte	Matte
75x75 cm - 29 1/2"x29 1/2"	± 9 mm	Matte	Matte	Matte	Matte
37.5x75 cm - 14 3/4"x29 1/2"	± 9 mm	Matte	Matte	Matte	Matte
60x60 cm - 23 5/8"x23 5/8"	± 9 mm	Matte	Matte	Matte	Matte
30x60 cm - 11 3/4"x23 5/8"	± 9 mm	Matte	Matte	Matte	Matte

Outdoor and Wet Areas

120x120 cm - 47 1/4"x47 1/4"	± 9 mm	Grip	Grip	Grip	Grip	Grip	Grip	Grip	Grip	Grip	Grip
60x120 cm - 23 5/8"x47 1/4"	± 9 mm										
30x60 cm - 11 3/4"x23 5/8"	± 9 mm										
120x240 cm - 47 1/4"x94 1/2"	± 20 mm	Textured		Textured							
120x120 cm - 47 1/4"x47 1/4"	± 20 mm	Textured		Textured	Textured	Textured		Textured	Textured		
60x120 cm - 23 5/8"x47 1/4"	± 20 mm	Textured		Textured	Textured	Textured		Textured	Textured		
90x90 cm - 35 3/8"x35 3/8"	± 20 mm	Textured		Textured	Textured	Textured		Textured	Textured		
60x60 cm - 23 5/8"x23 5/8"	± 20 mm	Textured		Textured	Textured	Textured		Textured	Textured		

Atlas Plan

162x324 cm - 63 3/4"x127 1/2"	± 12 mm	Hammered		Hammered	Hammered	Hammered						Hammered		
> Non rectified - non rettificato	± 20 mm				Hammered									

Wall tiles

Size	Thickness	Finish	Boost	Boost Pro	Boost Stone
40x80 cm - 15 3/4"x31 1/2"	± 8.5 mm	Matte	White	Pearl	Grey
	± 10 mm	Matte	Smoke	Sage	Red
40x80 cm - 15 3/4"x31 1/2" 3D Urban	± 8.5 mm	Matte	Ivory	Cream	Clay
	± 10 mm	Matte			Mustard

BOOSTWORLD

Range Summary

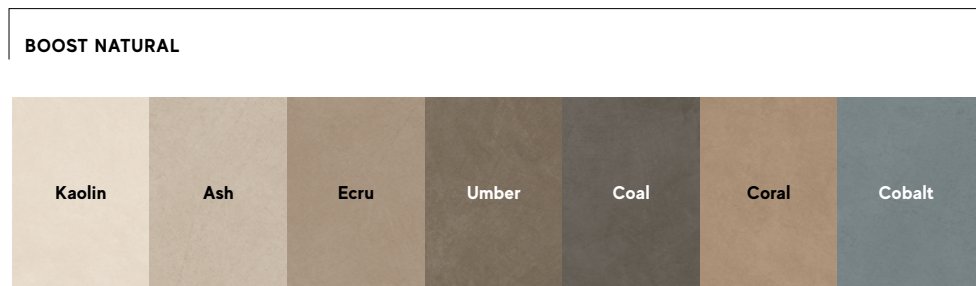

Porcelain tiles



Size	Thickness	Kaolin	Ash	Ecrú	Umber	Coal	Coral	Cobalt
160x320 cm - 63"x126"	± 6 mm							
160x160 cm - 63"x63"	± 6 mm							
120x278 cm - 47 1/4"x109 1/2"	± 6 mm	Matte	Matte	Matte	Matte	Matte	Matte	Matte
120x240 cm - 47 1/4"x94 1/2"	± 9 mm							
120x120 cm - 47 1/4"x47 1/4"	± 6 mm							
	± 9 mm	Matte	Matte	Matte	Matte	Matte	Matte	Matte
75x150 cm - 29 1/2"x59"	± 9 mm							
60x120 cm - 23 5/8"x47 1/4"	± 9 mm	Matte	Matte	Matte	Matte	Matte	Matte	Matte
75x75 cm - 29 1/2"x29 1/2"	± 9 mm							
37,5x75 cm - 14 3/4"x29 1/2"	± 9 mm							
60x60 cm - 23 5/8"x23 5/8"	± 9 mm	Matte	Matte	Matte	Matte	Matte		
30x60 cm - 11 3/4"x23 5/8"	± 9 mm	Matte	Matte	Matte	Matte	Matte		

Outdoor and Wet Areas

120x120 cm - 47 1/4"x47 1/4"	± 9 mm	Grip	Grip	Grip	Grip	Grip		
60x120 cm - 23 5/8"x47 1/4"	± 9 mm	Grip	Grip	Grip	Grip	Grip		
30x60 cm - 11 3/4"x23 5/8"	± 9 mm							
120x240 cm - 47 1/4"x94 1/2"	± 20 mm							
120x120 cm - 47 1/4"x47 1/4"	± 20 mm	Textured	Textured	Textured				
60x120 cm - 23 5/8"x47 1/4"	± 20 mm							
90x90 cm - 35 3/8"x35 3/8"	± 20 mm							
60x60 cm - 23 5/8"x23 5/8"	± 20 mm	Textured	Textured	Textured				

Atlas Plan

162x324 cm - 63 3/4"x127 1/2"	± 12 mm			Hammered				
> Non rectified - non rettificato	± 20 mm							

Wall tiles



Size	Thickness	Kaolin	Ash	Ecrú
50x120 cm - 19 5/8"x47 1/4"	± 8,5 mm	Matte	Matte	Matte
50x120 cm - 19 5/8"x47 1/4" 3D Brushed	± 8,5 mm	Matte	Matte	Matte
50x120 cm - 19 5/8"x47 1/4" 3D Texture	± 8,5 mm	Matte	Matte	Matte
50x120 cm - 19 5/8"x47 1/4" 3D Wave	± 8,5 mm	Matte	Matte	Matte



Boost World: system of surfaces

Boost World is a project featuring concrete- and stone-effect surfaces. A system of porcelain tiles and coordinated wall tiles that's unique in terms of style and potential combinations that Atlas Concorde has designed to meet the needs of contemporary architecture and interior design.

Boost World è un progetto di superfici effetto cemento ed effetto pietra. Un sistema di pavimenti in gres porcellanato e rivestimenti coordinati unico per stile e potenzialità combinatorie, che Atlas Concorde ha pensato per rispondere alle esigenze dell'architettura e dell'interior design contemporanei.

Boost World est un projet de surfaces effet béton et pierre. Un système de sols en grès cérame et de revêtements muraux coordonnés unique en termes de style et de potentiel combinatoire, qu'Atlas Concorde a conçu pour répondre aux besoins de l'architecture et du design d'intérieur contemporains.

Boost World ist ein Projekt aus Belägen in Zement- und Steinoptik. Ein System aus Feinsteinzeug-Bodenbelägen und passend darauf abgestimmten Wandbelägen von einzigartigem Stil und großem Kombinationspotenzial, das Atlas Concorde eigens für die zeitgenössische Architektur und das Innendesign entwickelt hat.

Boost World es un proyecto de superficies con efecto cemento y piedra. Un sistema de pavimentos de gres porcelánico y revestimientos a juego únicos por su estilo y potencialidad de combinación que Atlas Concorde ha diseñado para satisfacer las necesidades de la arquitectura y el diseño de interiores contemporáneos.

Boost World – это подборка коллекций плитки под цемент и камень. Речь идет о комплексной системе с уникальным потенциалом сочетаний, включающей напольный керамогранит и настенную плитку, которую компания Atlas Concorde разработала, чтобы удовлетворить даже самые взыскательные требования современной архитектуры и дизайна.

Porcelain tiles: a safe choice

Resistance and duration

RESISTENZA E DURATA

Easy to maintain

Facile da mantenere



Porcelain tiles do not require any special maintenance.

Il gres porcellanato non richiede manutenzioni particolari.

UV Resistant

Resistente ai raggi UV



Porcelain tiles maintain their colors even when exposed to continuous, direct sunlight or in contact with atmospheric agents or smog.

Il gres porcellanato rimane inalterato nei suoi colori anche se esposto alla luce diretta e continua del sole o a contatto con agenti atmosferici o smog.

Scratch resistant

Resistente al graffio



Porcelain tiles do not splinter, break or get damaged.

Il gres porcellanato non si scheggia, non si rompe e non si danneggia.

Easy to clean

Facile da pulire



Porcelain tiles are easy to clean.

Il gres porcellanato si pulisce facilmente.

Waterproof

Resistente all'acqua



Porcelain tiles are completely non-porous and therefore are not damaged by water or humidity.

Il gres porcellanato è completamente non poroso e non teme l'acqua e l'umidità.

Stain resistant

Resistente alle macchie



Porcelain tiles are waterproof, no liquid can damage the surface.

Il gres porcellanato è impermeabile e nessun tipo di liquido può danneggiarne la superficie.

Resistant to chemicals

Resistente agli agenti chimici



Porcelain tiles do not stain and resist the most aggressive chemical agents.

Il gres porcellanato non si macchia e resiste agli agenti chimici più aggressivi.

Resistant to acids

Resistente agli acidi



Porcelain tiles are resistant to acids found in food and cleaning products.

Il gres porcellanato resiste agli acidi di uso alimentare e domestico.

Resistant to thermal shock

Resistente agli shock termici



A porcelain tile floor will not change as a result of sharp temperature fluctuations.

Un pavimento in gres porcellanato non si altera a causa di sbalzi termici.

Frost resistant

Resistente al ghiaccio



Porcelain tiles are frost resistant and therefore are not damaged by low temperatures.

Il gres porcellanato è ingelivo e resiste alle temperature più basse.

Health

SALUTE

Zero VOCS

Zero VOC



Porcelain tiles are intrinsically inorganic and do not emit volatile organic compounds (VOC).

Le piastrelle in gres porcellanato sono intrinsecamente inorganiche e non emettono composti organici volatili.

Zero PVC

Zero PVC



Porcelain tiles contain no PVC, plastics or petroleum derivatives.

Il gres porcellanato è privo di PVC, plastiche o derivati del petrolio.

Zero formaldehyde

Zero formaldeide



Porcelain tiles do not contain formaldehyde.

Il gres porcellanato non contiene formaldeide.

Zero allergens

Zero allergeni



Porcelain tiles are inhospitable for mites, bacteria, fungi, molds, and other irritants.

Il gres porcellanato è inospitale per acari, batteri, funghi, muffe e altre sostanze irritanti.

Prevent bacterial growth

Previene la crescita batterica



Porcelain tiles are completely hygienic and inhospitable for bacteria, mites, molds, and fungi.

Il gres porcellanato è assolutamente igienico e inospitale per i batteri, acari, muffe e funghi.

Safety

SICUREZZA

Non-slip

Antiscivolo



Porcelain tile surfaces can be made with an abrasive surface grit that can increase traction and reduce the risk of slipping.

Le superfici in gres porcellanato possono essere realizzate con una graniglia abrasiva superficiale in grado di aumentare la trazione e ridurre i rischi di scivolamento.

Fire resistant

Resistente al fuoco



Porcelain tiles are not flammable, reduce the spread of flames, do not burn, and do not emit toxic fumes.

Le piastrelle in gres porcellanato non sono infiammabili, riducono la propagazione della fiamma, non bruciano e non emettono fumi tossici.

Heat resistant

Resistente al calore



Porcelain tiles do not change shape at high temperatures.

Il gres porcellanato non si altera alle alte temperature.

Environment

AMBIENTE

Energy efficiency

Efficienza energetica



The high thermal inertia of porcelain tiles moderates the changes in temperature of the rooms, favoring energy savings.

L'elevata inerzia termica del gres porcellanato modera gli sbalzi di temperatura degli ambienti, favorendo il risparmio energetico.

Ecological

Ecologico



Porcelain tiles have a low environmental impact at all stages of their production, from the raw materials to disposal and recycling.

Il gres porcellanato ha un basso impatto ambientale in tutte le fasi del suo processo industriale, dalle materie prime fino allo smaltimento e al riciclo.

Recycling and re-use

Riciclo e riutilizzo



Porcelain tiles are made with recycled materials, last a long time, and can be re-used because they retain their original appearance.

Il gres porcellanato è realizzato con materiali di riciclo, dura a lungo e mantenendo l'aspetto originario può essere riciclato.

Ideal for floor heating systems

Ideale per sistemi di riscaldamento a pavimento



Porcelain tiles can be effectively combined with floor heating systems.

Il gres porcellanato può essere abbinato in modo efficace a sistemi di riscaldamento a pavimento.



The benefits of porcelain tiles

SEE MORE



SCOPRI DI PIÙ



DÉCOUVREZ D'AVANTAGE



ERFAHREN SIE MEHR



LEER MÁS



УЗНАЙТЕ БОЛЬШЕ



SUSTAINABILITY

Atlas Concorde implements a rigorous policy of respect for the environment and quality of work, as demonstrated by the innovative procedures for sustainable management of the production process and the many certifications obtained from the most prestigious international bodies.

Atlas Concorde attua una rigorosa policy di rispetto dell'ambiente e della qualità del lavoro, come testimoniano le innovative procedure per una gestione sostenibile del processo produttivo e le numerose certificazioni ottenute dai più prestigiosi enti internazionali.



SEE MORE



SCOPRI DI PIU'



CERTIFICATIONS



MADE IN ITALY

The Made in Italy logo of Atlas Concorde stands for style, quality and ethics. Having firmly adhered to the Ethical Code promoted by Confindustria Ceramica, Atlas Concorde places the Made in Italy logo on all the products designed and produced in Italy, that is to say ceramic tiles, decorations and the majority of special trim tiles. Only a small amount of the latter is manufactured in Spain. Atlas Concorde products are produced using eco-friendly technologies, top quality and safe raw materials with the best working conditions guaranteed for our personnel. For these reasons, Atlas Concorde's Made in Italy is the expression of strong values such as style, design, product quality, and respect for the environment and the people who live in it.

Il marchio Made in Italy di Atlas Concorde è sinonimo di stile, qualità ed etica. Avendo aderito con convinzione al Codice Etico di Confindustria Ceramica, Atlas Concorde appone il marchio Made in Italy su tutti i prodotti studiati, progettati e realizzati in Italia, nella fattispecie tutte le piastrelle di ceramica, le decorazioni e la maggioranza dei pezzi speciali. Solo un ristretto numero di questi ultimi è fabbricato in Spagna. I prodotti Atlas Concorde sono inoltre realizzati con tecnologie rispettose dell'ambiente, utilizzando materie prime eccellenti e sicure, garantendo le migliori condizioni di lavoro. Per queste ragioni il Made in Italy di Atlas Concorde è espressione di valori forti quali stile, design, qualità del prodotto, attenzione all'ambiente e alle persone.



The Ceramics of Italy logo is an exclusive identification on ceramic products which have effectively been made in Italy by companies that are a part of the Confindustria Ceramica and who adhered to its Ethical Code. This Code, promoted and created by Confindustria Ceramica, commits all companies to communicate, clearly and with transparency, the origin of their products.

Il marchio Ceramics of Italy contrassegna esclusivamente i prodotti ceramici effettivamente realizzati in Italia da un'azienda associata a Confindustria Ceramica che ha sottoscritto il Codice Etico. Il Codice, redatto dalla stessa Confindustria Ceramica, impegna a comunicare con chiarezza l'origine dei prodotti.

www.ceramica.info

CERAMICHE ATLAS CONCORDE S.p.A.
Via Canaletto 141
41042 Spezzano di Fiorano (MO) - Italia

ATLAS CONCORDE USA, Inc.
117 Seaboard Lane - Suite F170
Franklin, TN 37067 - USA

ATLAS CONCORDE RUSSIA
Business centre "Meliora Place"
Prospekt Mira 6, 129090 Moscow - Russia

atlasconcorde.com



Copyright 2021 by Ceramiche Atlas Concorde S.p.A.
(Spezzano di Fiorano, MO - Italy)
September 2021